

LEGO® Education WeDo 2.0 Curriculum Pack



WeDo 2.0
2045300

Table of contents

Introduction to WeDo 2.0

3-11

WeDo 2.0 in Curriculum

12-28

Assess with WeDo 2.0

29-35

Classroom Management

36-39

Getting Started Projects

40-51

Guided Projects

52-156

Open Projects

157-181

WeDo 2.0 Toolbox

182-205

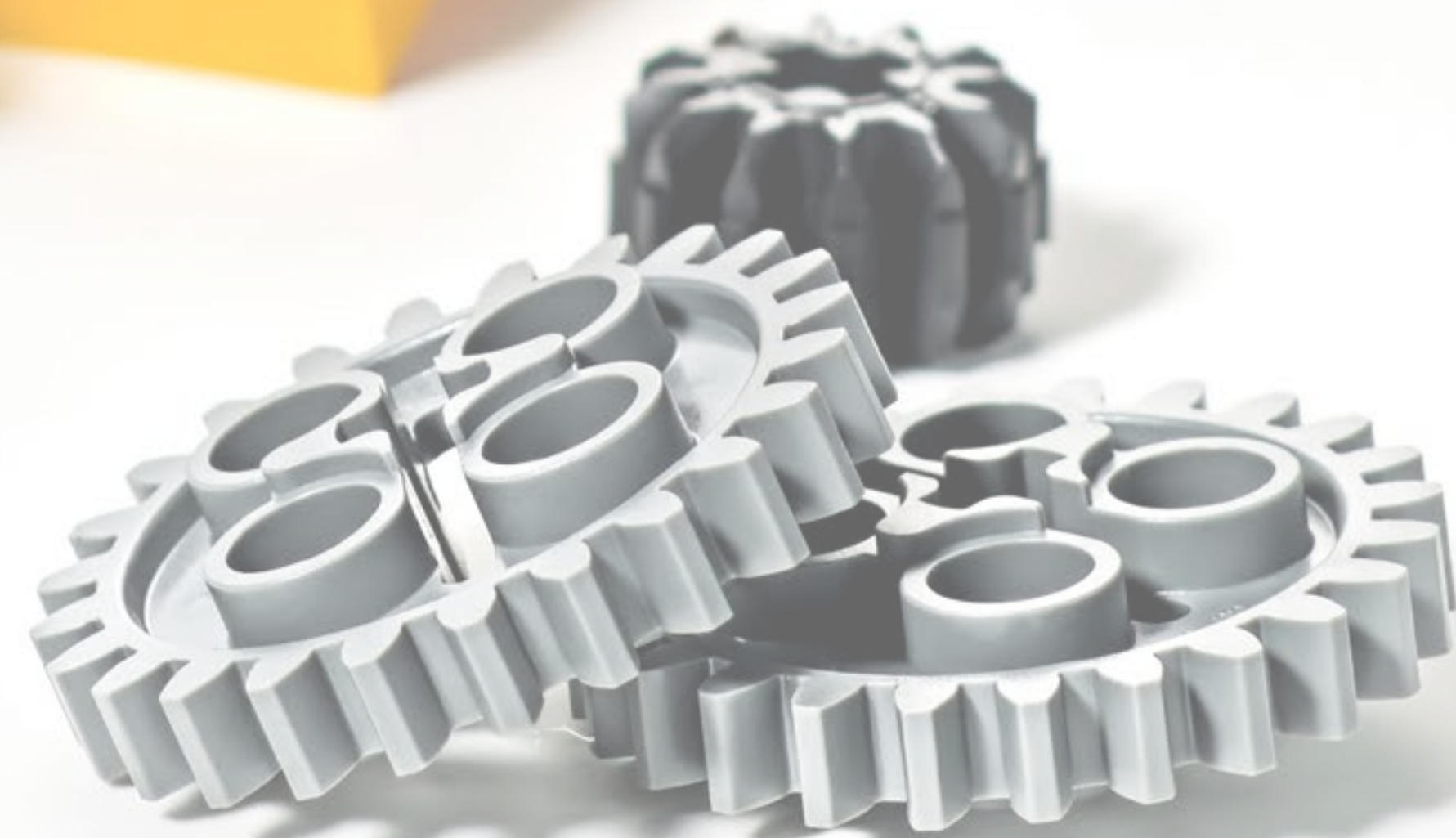

Introduction to WeDo 2.0

Welcome to the LEGO® Education WeDo 2.0 Curriculum Pack.

In this chapter, you will discover the fundamental steps needed for the journey you are about to experience.





LEGO® Education WeDo 2.0 Curriculum Pack

LEGO® Education WeDo 2.0 is developed to engage and motivate elementary students' interest in learning science- and engineering-related subjects. This is done through the use of motorized LEGO models and simple programming.

WeDo 2.0 supports a hands-on, "minds on" learning solution that gives students the confidence to ask questions and the tools to find the answers and to solve real-life problems.

Students learn by asking questions and solving problems. This material does not tell students everything they need to know. Instead it makes them question what they know and explore what they do not yet understand.

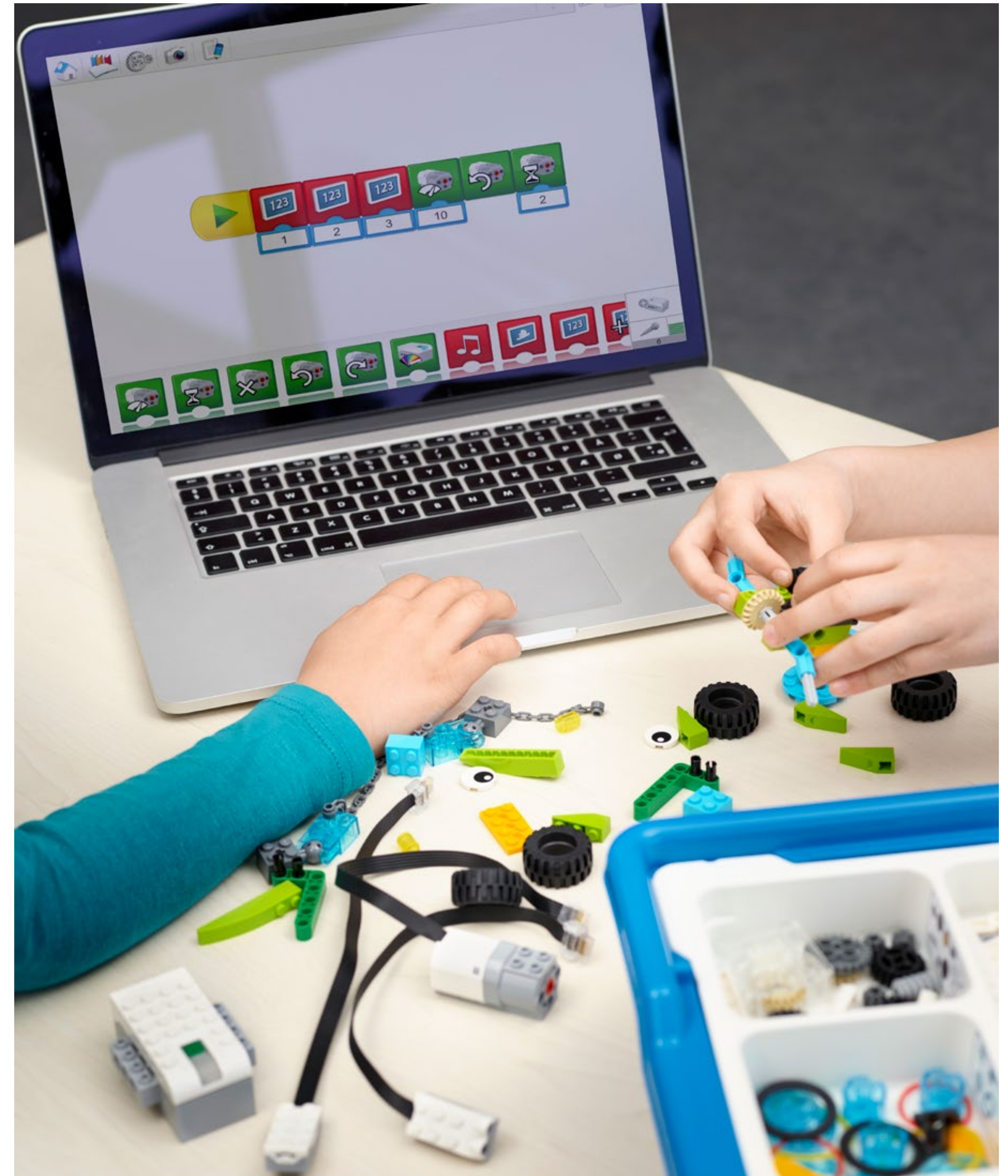



Learn science and engineering through projects

WeDo 2.0 has a range of different projects. The projects are divided into the following types:

- 1 Getting Started Project divided in 4 parts, to learn the basic functions of WeDo 2.0
- 8 Guided Projects linked to the curriculum standards, with step-by-step instructions for the complete project
- 8 Open Projects linked to the curriculum standards, with a more open experience

All 16 projects are divided into three phases: the Explore phase, to connect students to the task; the Create phase, to allow students to build and program; and the Share phase, to document and present their project.

Each project should last around three hours. Each phase has an equal importance in the project flow and could last around 45 min., but you can modify the time to spend on each.





How to teach science with WeDo 2.0

WeDo 2.0 uses a project progression defined by three phases.

Explore phase

Students connect to a scientific question or an engineering problem, establish a line of inquiry, and consider possible solutions.

The steps of the Explore phase are: connect and discuss.

Create phase

Students build, program, and modify a LEGO® model. Projects can be one of three types: investigate, design solutions, and use models. Depending on the type of project, the Create phase will differ from one project to another.

The steps of the Create phase are: build, program, and modify.

Share phase

Students present and explain their solutions using their LEGO models and the document they have created with their findings with the integrated Documentation tool.

The steps of the Share phase are: document and present.

▶ Important

During each of these phases, students will document their findings, the answers, and the process using various methods. This document can be exported and used for assessment, display, or sharing with parents.

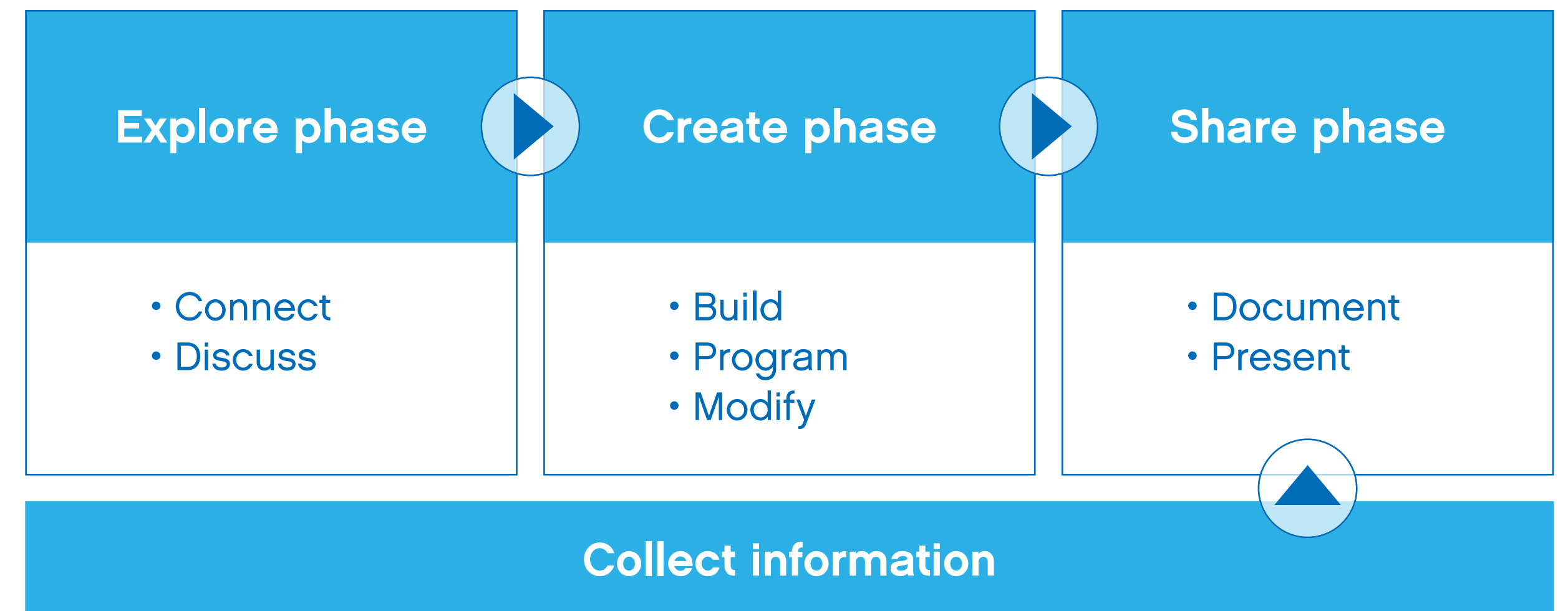



Use the Guided Projects

The Guided Projects will help you set the scene and facilitate the learning experience. The Guided Projects should build your students' confidence and provide the foundations necessary for success.

All Guided Projects follow the Explore, Create, and Share sequence to ensure that students progress step-by-step through the learning experience.

With every project teachers' notes have been provided that include:

- Curriculum links
- Detailed preparation
- Assessment grids
- Differentiation techniques and notes on possible student misconceptions.
- Explore, Create and Share Help panel

See the "Guided Projects" chapter to discover all Guided Projects.

▶ Suggestions

It is recommended that you start with the Getting Started Project followed by one or two Guided Projects to make sure students understand the approach and methodology. A good Guided Project to start with is called Pulling.





Using Open Projects

The Open Projects also follow the Explore, Create and Share sequence but intentionally do not offer the same step-by-step guidance as the Guided Projects. They provide an initial brief and starting points to build upon.

The key to using the Open Projects is to make them your own; offer opportunities for projects that are locally relevant and challenging in the areas you want them to be. Use your creativity to adapt these project ideas to suit your students. You will find teacher support about Open Projects in the “Open Projects” chapter.

With every Open Projects brief, students will be given three suggested base models to look at in the Design Library.

The Design Library, located in the software, has been designed to provide inspiration for students to build their own solution. Therefore, the goal is not to replicate the model but to get help on how to build a function, such as to lift or walk. Students will find building instructions for the 15 base models in the Design Library and pictures for inspirational models.

▶ Suggestion

The Design Library and Open Projects can be found in the WeDo 2.0 Software.





Document projects

Having your students document their work is one of many ways you can keep track of their work, identify where they need more help, and evaluate their progress.

Students can use many different methods to express their ideas. During the ongoing documentation process, they can:

1. Take pictures of important steps of their prototype or their final models.
2. Take pictures of the team working on something important.
3. Record a video explaining a problem they are facing.
4. Record a video explaining their investigation.
5. Write critical information within the Documentation tool.
6. Find supporting pictures on the Internet.
7. Take a screen capture of their program.
8. Write, draw, or sketch on paper and take a photo of it.

▶ Suggestion

Depending on the age group you work with, the combination of paper and digital documentation can be the richest.





Share projects

At the end of the project, students will be excited to share their solutions and findings. It will be a great opportunity to develop their communication ability.

Here are different ways you can have your students share their work:

1. Have students create the display where the LEGO® model will be used.
2. Have students describe their investigation or diorama.
3. Have a team of students present their best solution to you, to another team, or in front of the class.
4. Have an expert (or some parents) come to your class to listen to your students.
5. Organize a science fair at your school.
6. Have students record a video to explain their project and post it online.
7. Create and display posters of the projects in your school.
8. E-mail the project document to parents or publish in student portfolios.

▶ Suggestion

To make this experience even more positive, have students give one positive comment or ask one question about others' work when they take part in the sharing session.





The Science Lab

Max and Mia's virtual WeDo 2.0 Science Lab is a great place for students to get connected to real-life questions or problems. You can meet them in every Guided Project.

Max is always ready for a new project. He loves to discover new topics, and he is really creative when it is time to invent something new.

Mia is thrilled by any discoveries. She is very curious about the world around her, and she always wants to know more.

In the Getting Started Project, Max and Mia are joined by Milo, the Science Rover, who is capable of great discoveries.

Max and Mia have great projects to propose and they are excited to **welcome you to the LEGO® Education WeDo 2.0 Science Lab!**



WeDo 2.0 in Curriculum

The LEGO® Education WeDo 2.0 solution combines LEGO bricks with Next Generation Science Standards (NGSS). The projects are designed to develop student science practices.

In this chapter, you will be introduced to three innovative ways to use the bricks in your classroom:

- Model reality.
- Conduct investigations.
- Use design skills alongside the development of science practices.





Experience overview

The WeDo 2.0 projects are developed with science and engineering practices from the NGSS in mind.

These practices represent NGSS's expectations for students to learn scientific knowledge as well as the practical skills. The practices are not to be seen as separate, rather as an interconnected set of expectations for students.

The crosscutting themes are also important, and teachers are encouraged to view NGSS documents for those themes as well as specific content area standards.

Both English Language Arts and Math Common Core State Standards (CCSS) are interwoven throughout the document and are used within the WeDo 2.0 curriculum.

The “habits of mind,” as outlined in *Engineering Habits of Mind* (EHoM) and defined by the National Academy of Engineering (NAE) and the National Research Council (NRC), are an important part of project-based learning.

The habits of mind are found throughout the practices and standards for all grade levels. The habits of mind are centered on the fact that science is about the attitudes, values, and skills that determine how people learn and acquire knowledge about the world.

According to both the NAE and NRC, there are six habits of mind that are essential for science and engineering growth:

1. Systems thinking
2. Creativity
3. Optimism
4. Collaboration
5. Communication
6. Ethical considerations

The WeDo 2.0 curriculum projects are built upon the habits of mind and interconnected throughout the practices and standards.



Develop science and engineering practices with WeDo 2.0

WeDo 2.0 projects will develop science practices. They provide opportunities for students to work with and develop ideas and knowledge as well as an understanding of the world around them.

The progression and difficulty level in the projects allow students to develop competency while exploring and learning about key science topics. The projects have been carefully chosen to cover a wide variety of topics and issues.

WeDo 2.0 projects develop eight science and engineering practices:

1. Ask questions and solve problems.
2. Use models.
3. Design prototypes.
4. Investigate.
5. Analyze and interpret data.
6. Use computational thinking.
7. Engage in argument from evidence.
8. Obtain, evaluate, and communicate information.

The guiding principle is that every student should engage in all of these practices across the projects in each grade.



Science practices and the engineering habits of mind

The science and engineering practices serve as the common thread throughout the curriculum, and all standards should, in essence, be taught through them.

While the academic definition of each process is important, it is probably a good habit to verbalize the practices in a way that is understandable to students at that level.

The following identifies the basic principles of these practices and gives examples on how they are used in WeDo 2.0 projects.

1. Ask questions and define problems.

This practice focuses on simplistic problems and questions based upon observational skills.

2. Develop and use models.

This practice focuses upon students' prior experiences and the use of concrete events in modeling solutions to problems. It also includes improving models and new ideas about a real-world problem and solution.

3. Plan and carry out investigations.

This practice is about how students learn and follow directions for an investigation to formulate probable solution ideas.

4. Analyze and interpret data.

The focus of this practice is to learn ways to gather information from experiences, document discoveries, and share ideas from the learning process.



Science practices and the engineering habits of mind

5. Use mathematics and computational thinking.

The purpose of this practice is to realize the role of numbers in data-gathering processes. Students read and gather data about investigations, make charts, and draw diagrams resulting from the numerical data. They add simple data sets to come up with conclusions. They understand or create simple algorithms.

6. Construct explanations and design solutions.

This practice is about ways they might go about constructing an explanation or designing a solution for a problem.

7. Engage in argument from evidence.

Constructively share ideas based upon evidence that it is an important feature of science and engineering. This practice is about how students begin to share their ideas and demonstrate proof to others in a group.

8. Obtain, evaluate, and communicate information.

Teaching children what real scientists do is key to this practice. The way in which they set up and complete investigations to gather information, how they evaluate their findings, and how they document are all important elements. It is important that teachers explore a plethora of ways to have students gather, record, evaluate, and communicate their findings. Ideas include digital presentations, portfolios, drawings, discussion, video, and interactive notebooks.

▶ Important

The WeDo 2.0 projects will engage your students in all science and engineering practices. Refer to the practices grid of this chapter to get the overview.



Use the LEGO® bricks in a scientific context

LEGO® bricks have been used in three different ways in the WeDo 2.0 projects:

1. To model reality
2. To investigate
3. To design

These three ways will give you the opportunity to develop a different set of practices, as the outcome of the project is different in each case.

1. Use models

Students represent and describe their ideas using the bricks.

Students can build a model to gather evidence or provide a simulation. Although only representations of reality, models enhance understanding and explain natural phenomena.

When implementing a modeling project, encourage students to focus their creativity on representing the reality as accurately as possible. By doing that, they will need to identify and explain the limitations of their models.

Examples of modeling Guided Projects are:

- Frog's Metamorphosis
- Plants and Pollinators

2. Investigate

Planning and carrying out investigations is an ideal framework for a science project. Students' learning is enhanced by active engagement with the problem. Students are encouraged to make predictions, carry out tests, collect data and draw conclusions.

When implementing an investigation project, you should encourage students to pay special attention to ensure fair testing. Ask them to search for cause and effect in their tests, ensuring they change only one variable at a time.

Examples of investigating Guided Projects are:

- Pulling
- Speed
- Robust Structures



Use the LEGO® bricks in an engineering context

3. Design

Students design solutions for a problem for which there is no single answer.

The problem may require students to design a combination of plans, models, simulations, programs, and presentations. Going through the design process will require students to constantly adjust and modify their solutions to meet criteria.

While designing a solution, it will be important to recognize that the idea of “failure” in engineering is a sign of growth in the cognitive process. Therefore, students may not get a viable solution on the first try or within the provided time constraints. In that case, have them reflect on their process to identify what they have learned.

When you implement a design project, encourage students to focus their creativity on designing multiple solutions. Ask them to select the prototype they think is the best according to the criteria you have set.

Examples of designing Guided Projects are:

- Prevent Flooding
- Drop and Rescue
- Sort to Recycle

Important

Documents produced by students following the completion of these three types of projects may contain different types of information.



Use LEGO® bricks in a computational thinking context

Computational thinking is a set of problem-solving skills that are applied to working with computers and other digital devices. In WeDo 2.0, computational thinking is handled in a developmentally appropriate manner through the use of icons and programming blocks.

Computational thinking characteristics include:

- Logical reasoning
- Looking for patterns
- Organizing and analyzing data
- Modeling and simulations
- Using computers to assist in testing models and ideas
- Using algorithms to sequence actions

Its application in science and engineering projects enables students to use powerful digital tools to carry out investigations and build and program models, which might otherwise be tricky to do. Students use programs to activate motors, lights, sounds, or displays, or to react to sounds, tilt, or movement to implement functionalities to their models or prototypes.





Visual overview of Guided Projects

1. Pulling

Investigate the effects of balanced and unbalanced forces on the movement of an object.

2. Speed

Investigate what factors can make a car go faster to help predict future motion.

3. Robust Structures

Investigate what characteristics of a building would help make it resistant to an earthquake using an earthquake simulator constructed from LEGO® bricks.

4. Frog's Metamorphosis

Model a frog's metamorphosis using a LEGO representation, and identify the characteristics of the organism at each stage.

5. Plants and Pollinators

Model a LEGO representation of the relationship between a pollinator and flower during the reproduction phase.

6. Prevent Flooding

Design an automatic LEGO floodgate to control water according to various precipitation patterns.

7. Drop and Rescue

Design a device to reduce the impacts on humans, animals, and the environment after an area has been damaged by a weather-related hazard.

8. Sort to Recycle

Design a device to use physical properties of objects, including their shape and size, to sort them.

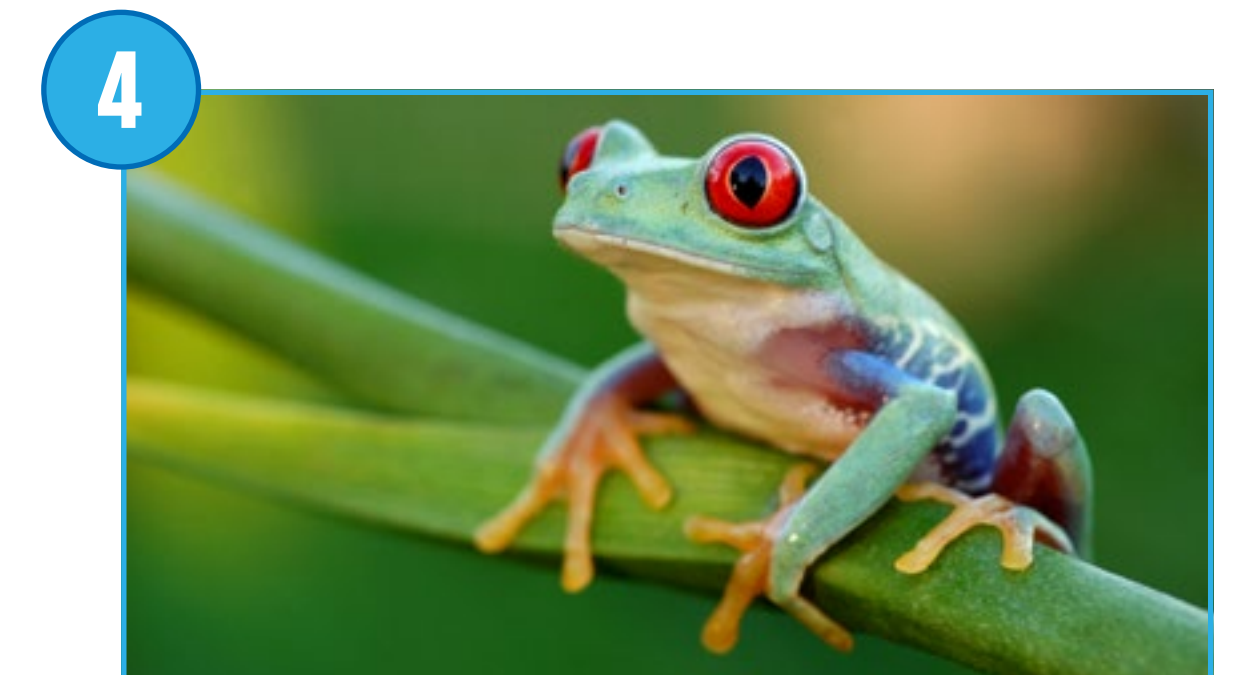
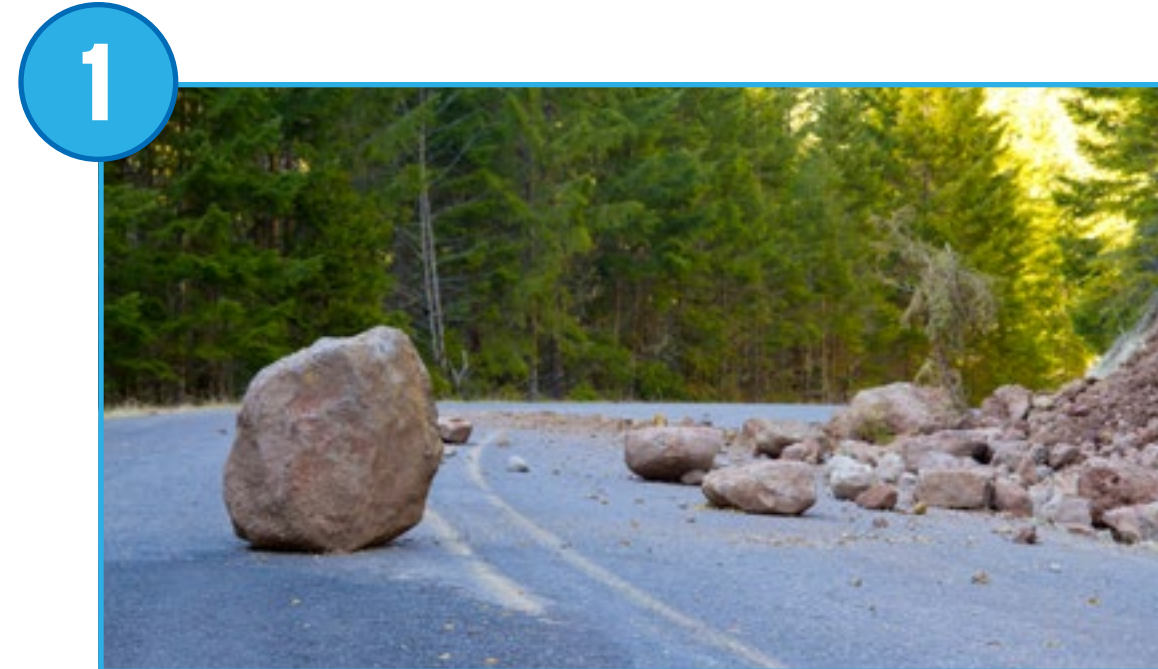



Visual overview of Open Projects

9. Predator and Prey

Model a LEGO® representation of the behaviors of several predators and their prey.

10. Animal Expression

Model a LEGO representation of various communication methods in the animal kingdom.

11. Extreme Habitats

Model a LEGO representation of the influence of the habitat on the survival of some species.

12. Space Exploration

Design a LEGO prototype of a rover that would be ideal for exploring distant planets.

13. Hazard Alarm

Design a LEGO prototype of a weather alarm device to reduce the impact of severe storms.

14. Cleaning the Ocean

Design a LEGO prototype to help people remove plastic waste from the ocean.

15. Wildlife Crossing

Design a LEGO prototype to allow an endangered species to safely cross a road or other hazardous area.

16. Moving Materials

Design a LEGO prototype of a device that can move specific objects in a safe and efficient way.

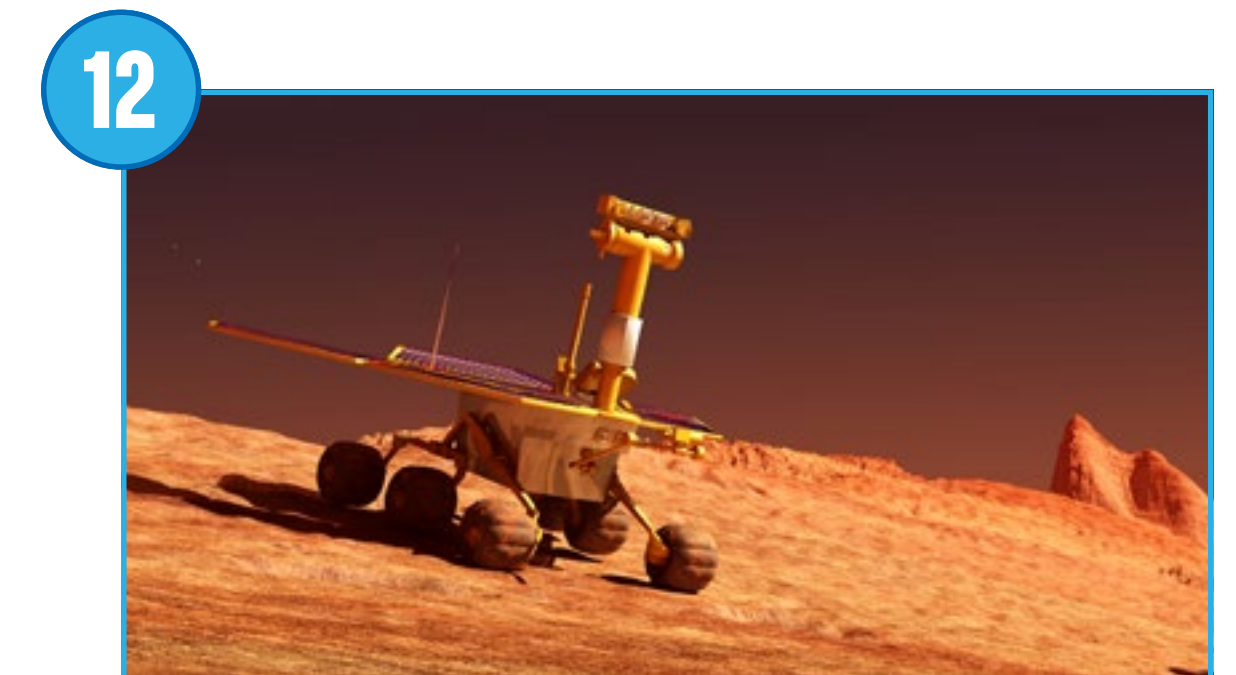
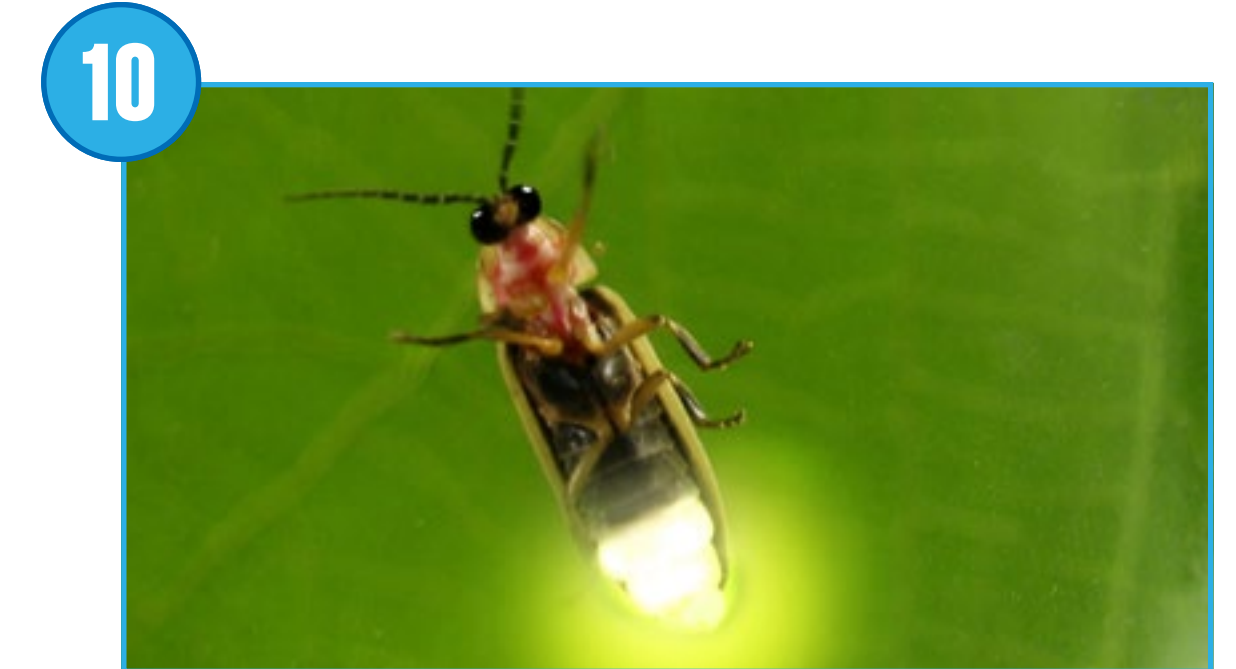



Curriculum overview of Guided Projects organized by NGSS disciplinary core ideas

	1 Pulling	2 Speed	3 Robust Structures	4 Frog's Metamorphosis	5 Plants and Pollinators	6 Prevent Flooding	7 Drop and Rescue	8 Sort to Recycle
Life Sciences				3-LS1-1 3-LS3-1 3-LS3-2	2-LS2-2 4-LS1-1			
Earth and Space Sciences			4-ESS3-2			2-ESS2-1 3-ESS3-1 3-ESS2-1 4-ESS2-2	3-ESS3-1	2-PS1-1
Physical Sciences	3-PS2-1	3-PS2-2 4-PS3-1						
Engineering, Technology, and Applications of Science	3-5-ETS-1-2		3-5-ETS-4-3			3-5-ETS-1-2	3-5-ETS-1-2	K-2-ETS-1-2



Curriculum overview of Open Projects organized by NGSS disciplinary core ideas

	9 Predator and Prey	10 Animal Expression	11 Extreme Habitats	12 Space Exploration	13 Hazard Alarm	14 Cleaning the Ocean	15 Wildlife Crossing	16 Moving Materials
Life Sciences	3-LS4-3	3-LS4-2 4-PS4-3 4-LS1-2	2-LS4-1 3-LS3-2 3-LS4-1				2-LS4-1 3-LS4-4	
Earth and Space Sciences					3-ESS3-1			
Physical Sciences								2-PS1-3
Engineering, Technology, and Applications of Science				3-5-ETS1-2 3-5-ETS1-3	3-5-ETS1-2	3-5-ETS1-1 3-5-ETS1-2	K-2-ETS1-1 K-2-ETS1-3	K-2-ETS1-2



NGSS performance expectations: Grade 2

Life science

2-LS2-1. Plan and conduct an investigation to determine if plants need sunlight and water to grow.

2-LS2-2. Develop a simple model that mimics the function of an animal in dispersing seeds or pollinating plants.

2-LS4-1. Make observations of plants and animals to compare the diversity of life in different habitats.

Physical science

2-PS1-1. Plan and conduct an investigation to describe and classify different kinds of materials by their observable properties.

2-PS1-2. Analyze data obtained from testing different materials to determine which materials have the properties that are best suited for an intended purpose.

2-PS1-3. Make observations to construct an evidence-based account of how an object made of a small set of pieces can be disassembled and made into a wholly new object.

2-PS1-4. Construct an argument with evidence that some changes caused by heating or cooling can be reversed and some cannot.

Earth and space science

2-ESS1-1. Use information from several sources to provide evidence that earth events can occur quickly or slowly.

2-ESS2-1. Compare multiple solutions designed to slow or prevent wind or water from changing the physical shape of the land.

2-ESS2-2. Develop a model to represent the shapes and kinds of land and bodies of water in an area.

2-ESS2-3. Obtain information to identify where water is found on earth and understand that it can be solid or liquid.

Engineering

K-2-ETS1-1. Ask questions, make observations, and gather information about a situation people want to change in order to define a simple problem that can be solved through the development of a new or improved object or tool.

K-2-ETS1-2. Develop a simple sketch, drawing, or physical model to illustrate how the shape of an object helps it function as needed to solve a problem.

K-2-ETS1-3. Analyze data from tests of two objects designed to solve the same problem to compare the strengths and weaknesses of how each performs.



NGSS performance expectations: Grade 3

Physical science

- 3-PS2-1.** Plan and conduct an investigation to provide evidence of the effects of balanced and unbalanced forces on the motion of an object.
- 3-PS2-2.** Make observations and/or measurements of an object's motion to provide evidence that a pattern can be used to predict future motion.
- 3-PS2-3.** Ask questions to determine cause and effect relationships of electric or magnetic interactions between two objects not in contact with each other.
- 3-PS2-4.** Define a simple design problem that can be solved by applying scientific ideas about magnets.

Earth and space science

- 3-ESS2-1.** Represent data in tables and graphic displays to describe typical weather conditions expected during a particular season.
- 3-ESS2-2.** Obtain and combine information to describe climates in different regions of the world.
- 3-ESS3-1.** Make a claim about the merit of a design solution that reduces the impacts of a weather-related hazard.

Engineering

- 3-5-ETS1-1.** Define a simple design problem reflecting a need that includes specified criteria for success and constraints on materials, time, or cost.
- 3-5-ETS1-2.** Generate and compare multiple, possible solutions to a problem based on how well each meets the criteria and constraints of the problem.
- 3-5-ETS1-3.** Plan and carry out fair tests in which variables are controlled and failure points are considered to identify aspects of a model or prototype that can be improved.

Life science

- 3-LS2-1.** Construct an argument that some animals from groups that help members survive.
- 3-LS4-1.** Analyze and interpret data from fossils to provide evidence of the organisms and the environments in which they lived long ago.
- 3-LS4-3.** Construct an argument with evidence that in a particular habitat some organisms can survive well, some survive less well, and some cannot survive at all.
- 3-LS4-4.** Make a claim about the merit of a solution to a problem that is caused when the environment changes and the types of plants and animals that live there may also change.
- 3-LS1-1.** Develop models to describe that organisms have unique and diverse life cycles but all have in common birth, growth, reproduction, and death.
- 3-LS3-1.** Analyze and interpret data to provide evidence that plants and animals have traits inherited from parents and that variations of these traits exist in a group of similar organisms.
- 3-LS3-2.** Use evidence to support the explanation that traits can be influenced by the environment.
- 3-LS4-2.** Use evidence to construct an explanation for how the variations in characteristics among individuals of the same species may provide advantages in surviving, finding mates, and reproducing.



NGSS performance expectations: Grade 4

Energy

4-PS3-1. Use evidence to construct an explanation relating the speed of an object to the energy of that object.

4-PS3-2. Make observations to provide evidence that energy can be transferred from place to place by sound, light, heat, and electric currents.

4-PS3-3. Ask questions and predict outcomes about the changes in energy that occur when objects collide.

4-PS3-4. Apply scientific ideas to design, test, and refine a device that converts energy from one form to another.

4-ESS3-1. Obtain and combine information to describe the fact that energy and fuels are derived from natural resources and that their use will affect the environment.

Structure, function, and information processing

4-PS4-2. Develop a model to describe how light reflecting from objects and entering the eye of a sighted person allows objects to be seen.

4-LS1-1. Construct an argument that plants and animals have internal and external structures that function to support their survival, growth, behavior, and reproduction.

4-LS1-2. Use a model to describe how animals receive different types of information through their senses, then process the information in their brain, and respond to the information in a range of different ways.

Waves: Waves and information

4-PS4-1. Develop a model of waves to describe patterns in terms of amplitude and wavelength and that waves can cause objects to move.

4-PS4-3. Generate and compare multiple solutions that use patterns for the transfer of information.

Earth's systems: Processes that shape the earth

4-ESS1-1. Identify evidence from patterns in rock formations and fossils in rock layers to support an explanation for changes in a landscape over time.

4-ESS2-1. Make observations and/or measurements to provide evidence of the effects of weathering or the rate of erosion by water, ice, wind, or vegetation.

4-ESS2-2. Analyze and interpret data from maps to describe patterns of earth's features.

4-ESS3-2. Generate and compare multiple solutions to reduce the impacts of natural earth processes on humans.

Engineering

3-5-ETS1-1. Define a simple design problem reflecting a need or a want that includes criteria for success and constraints on materials, time, or cost.

3-5-ETS1-2. Generate and compare possible solutions to a problem based on how well each is likely to meet the criteria and constraints of the problem.

3-5-ETS1-3. Plan and carry out fair tests in which variables are controlled and failure points are considered to identify aspects of a model or prototype that can be improved.



Curriculum overview of Guided Projects organized by NGSS practices

	1 Pulling	2 Speed	3 Robust Structures	4 Frog's Metamorphosis	5 Plants and Pollinators	6 Prevent Flooding	7 Drop and Rescue	8 Sort to Recycle
Practice 1: Ask questions and define problems	●	●	●	●	●	●	●	●
Practice 2: Develop and use models				●	●			
Practice 3: Plan and carry out investigations	●	●	●					
Practice 4: Analyze and interpret data	●	●	●					
Practice 5: Use mathematics and computational thinking	●	●	●	●	●	●	●	●
Practice 6: Construct explanations and design solutions						●	●	●
Practice 7: Engage in argument from evidence	●	●	●	●	●	●	●	●
Practice 8: Obtain, evaluate, and communicate information	●	●	●	●	●	●	●	●



Curriculum overview of Open Projects organized by NGSS practices

	9 Predator and Prey	10 Animal Expression	11 Extreme Habitats	12 Space Exploration	13 Hazard Alarm	14 Cleaning the Ocean	15 Wildlife Crossing	16 Moving Materials
Practice 1: Ask questions and define problems	●	●	●	●	●	●	●	●
Practice 2: Develop and use models	●	●			●			
Practice 3: Plan and carry out investigations								●
Practice 4: Analyze and interpret data								
Practice 5: Use mathematics and computational thinking	●	●	●	●	●	●	●	●
Practice 6: Construct explanations and design solutions			●	●		●	●	●
Practice 7: Engage in argument from evidence	●	●	●	●	●	●	●	●
Practice 8: Obtain, evaluate, and communicate information	●	●	●	●	●	●	●	●

Assess with WeDo 2.0

There are many ways you can monitor and assess your students' progress through a WeDo 2.0 project. Here are explicit assessment tools you could use, including:

- Anecdotal record grid
- Observation rubrics grid
- Documentation pages
- Self-assessment statements

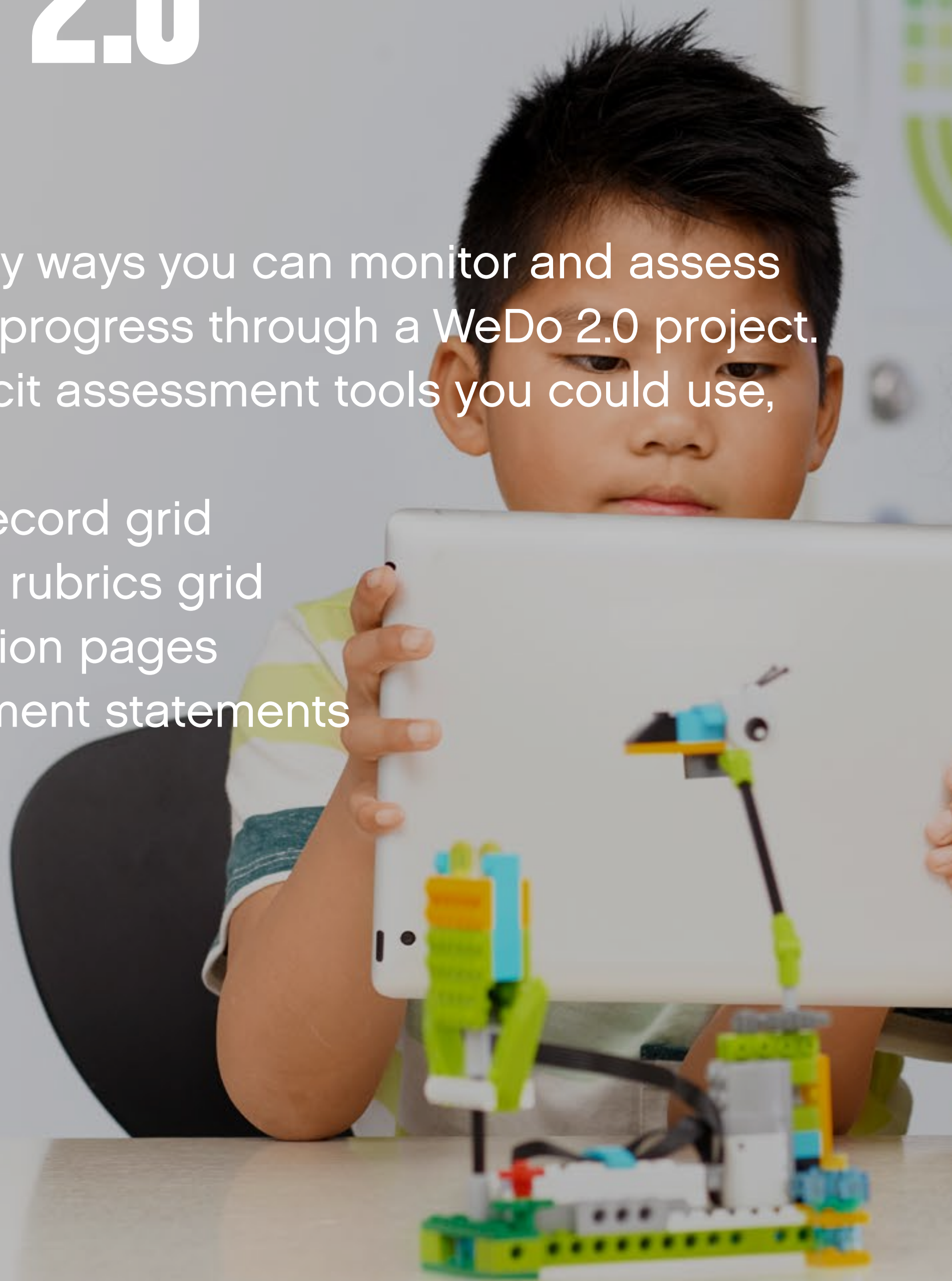



Teacher-led assessment

Developing students' science and engineering practices takes time and feedback. Just as in the design cycle, in which students should know that failure is part of the process, assessment should provide feedback to students in terms of what they did well and where they can improve.

Problem-based learning is not about succeeding or failing. It is about being an active learner and continually building upon and testing ideas.

Anecdotal record grid

The anecdotal record grid lets you record any type of observation you believe is important about each student. Use the template on the next page to provide feedback to students about their learning progress as required.





Anecdotal record grid

Name: _____ Class: _____ Project: _____

Emerging	Developing	Proficient	Accomplished

Notes:



Teacher-led assessment

Observation rubrics

An example of rubrics has been provided for every Guided Project. For every student, or every team, you can use the Observation rubrics grid to:

- Evaluate student performance at each step of the process.
- Provide constructive feedback to help the student progress.

Observation rubrics provided in the Guided Projects can be adapted to fit your needs. The rubrics are based on these progressive stages:

1. Emerging

The student is at the beginning stages of development in terms of content knowledge, ability to understand and apply content, and/or demonstration of coherent thoughts about a given topic.

2. Developing

The student is able to present basic knowledge only (vocabulary, for example), and cannot yet apply content knowledge or demonstrate comprehension of concepts being presented.

3. Proficient

The student has concrete levels of comprehension of content and concepts and can demonstrate adequately the topics, content, or concepts being taught. The ability to discuss and apply outside the required assignment is lacking.

4. Accomplished

The student can take concepts and ideas to the next level, apply concepts to other situations, and synthesize, apply, and extend knowledge to discussions that include extensions of ideas.

▶ Suggestion

You can use the observation rubrics grid on the next page to keep track of your students' progress.





Observation rubrics grid

Class:		Project					
Students' names		NGSS			ELA		
		Explore	Create	Share	Explore	Create	Share
1							
2							
3							
4							
5							
6							
7							
8							
9							
10							
11							
12							
13							
14							
15							

Project					
NGSS			ELA		
Explore	Create	Share	Explore	Create	Share

Project					
NGSS			ELA		
Explore	Create	Share	Explore	Create	Share

To be used with the rubrics description in the “Guided Projects” chapter (1. Emerging, 2. Developing, 3. Proficient, 4. Accomplished).



Student-led assessment

Documentation pages

Each project will ask students to create documents to summarize their work.

To have a complete science report, it is essential that students:

- Document with various types of media.
- Document every step of the process.
- Take the time to organize and complete their document.

It is most likely that the first document your students will complete will not be as good as the next one:

- Allow them time and feedback to see where and how they can improve some parts of it.
- Have your students share the documents with each other. By communicating their scientific findings, students are engaged in the work of scientists.

Self-assessment statements

After each project, students can reflect on the work they have done. Use the following page to encourage reflection and set goals for the next project.





Student self-assessment rubric

Name: _____ Class: _____ Project: _____

	Explore	Create	Share
	I documented and used my best reasoning in connection with the question or problem.	I did my best work to solve the problem or question by building and programming my model and making changes when needed.	I documented important ideas and evidence throughout my project and gave my very best when presenting to others.
1			
2			
3			
4			

Project reflection

One thing I did really well was: _____

One thing I want to improve upon for next time is: _____

Classroom Management

In this chapter, you will find information and guidance to ease the implementation of WeDo 2.0 in your classroom.

The secret for success resides in some key elements:

- Good material preparation
- Good classroom disposition
- Good WeDo 2.0 project preparation
- Good guidance of students





Prepare the material

Prepare the material

1. Install the software on computers or tablets.
2. Open each LEGO® Education WeDo 2.0 core set and sort the elements.
3. Attach the labels to the relevant compartments in the sorting tray.
4. You may want to identify and label the box, Smarthub, motor, and sensors with a number. That way, you can sign out a numbered kit to each student or team. You may find it helpful to also display the parts list in the classroom.
5. Put two AA batteries in the Smarthub or use the supplementary Smarthub Rechargeable Battery.

Suggestion

To strongly improve your classroom experience, it is recommended that you give a name to each Smarthub from the list in the Connection Center.

When you access the Connection Center:

1. Press on the button on the Smarthub.
2. Locate the Smarthub name in the list.
3. Long Press on the name you want to change.
4. At this point, you will be able to enter a name of your choice.

You can insert names following a code, such as:

- WeDo-001
- WeDo-002
- etc.

By doing this, it will be easier for the students to connect with the right Smarthub.



Before you start a project

Classroom disposition

1. Organize a cabinet, a wheeled cart, or other space to store the sets between sessions.
2. If not already available in your classroom, prepare a box of measuring tools, including rulers or measuring tapes and paper, for collecting data and making charts.
3. Ensure there is enough space in the classroom for the project to happen.
4. When planning the projects, ensure enough time for the students to store their models or put the parts back in the box at the end of a session.

Teacher preparation

1. Spend some time exploring the bricks in the set, and decide on a few key expectations to determine what to do when the WeDo 2.0 materials are used in class.
2. Set aside an hour and try the Getting Started Project as if you were a student.
3. Read the overview and projects description in the “Open Projects” chapter and select the project you wish to do.
4. Review the planning of the project you have selected.

Now you are good to go!





Student guidance

It is important to establish good classroom management habits when working with the WeDo 2.0 sets and digital devices.

It may be helpful to establish clear expectations for team roles:

- WeDo 2.0 projects are optimal for a team of two students working together.
- Have students work to their strengths in their groups.
- Make adjustments for challenging teams who are ready to develop new skills and improve further.
- Assign or have students determine specific roles for each team member.

Suggestion

Assign a role to each student so the team can foster collaboration and cooperation skills. Here are some roles you could use:

- Builder, brick picker
- Builder, brick assembler
- Programmer, creating the program strings
- Documenter, taking photos and videos
- Presenter, explaining the project
- Team captain

It is also a good idea to rotate roles, to let every student experience all components of the project, and, therefore, get the chance to develop a range of skills.

Getting Started Projects

Milo, the Science Rover
41-45



Milo's Motion Sensor
46-47



Milo's Tilt Sensor
48-49



Collaborate
50-51



Getting Started Project, part A

Milo, the Science Rover

This project is about discovering ways that scientists and engineers can use rovers to explore places where humans cannot go.





Quick glance: Getting Started Project, part A

Preparation: 30 min.

- See the general preparation in the “Classroom Management” chapter.
- Read this project so you have a good idea of what to do.
- Prepare to introduce this project to your students.
- Define your expectations and theirs.
- Determine the end result of this project:
Everyone should have a chance to build, program, and document.
- Make sure timing allows for expectations to be met.

Explore phase: 10 min.

- Start the project using the introductory video.
- Have a group discussion.

Create phase: 20 min.

- Have students build the first model from the provided building instructions.
- Let them program the model with the sample program.
- Allow students time so they can make their own experiment and change the parameters of the program.
- Challenge them to discover new programming blocks on their own.

Share phase: 10 min.

Some suggestions for sharing include:

- Make sure your students take photos of their model.
- Make sure they write their names and comments in the Documentation tool.
- Have your students export the results of their project and share it with their parents.

▶ Important

It is recommended that you complete the four Getting Started Projects in a single sequence. If not, then it is preferable that you complete these prior to continuing on to other projects in order to provide students ample time to explore the materials.

Approximate timing for the four Getting Started Projects is:

- Part A: Milo, the Science Rover: 40 min.
- Part B: Milo's Motion Sensor: 15 min.
- Part C: Milo's Tilt Sensor: 15 min.
- Part D: Collaborate: 15 min.



Explore phase

Use the introductory video

Scientists and engineers have always challenged themselves to explore remote places and make new discoveries. To succeed in this journey, they have designed spacecraft, rovers, satellites, and robots to help them see and collect data about these new places. They have succeeded many times and failed many times, too. Remember that failure is a chance to learn more. Use the following ideas to start thinking like a scientist:

1. Scientists send rovers on Mars.
2. They use submarines in water.
3. They fly drones in a volcano.

Questions for discussion

1. What do scientists and engineers do when they cannot go where they want to explore?

Scientists and engineers take these situations as challenges they want to solve. With proper resources and commitment, they will develop prototypes as possible solutions and ultimately choose the best option.

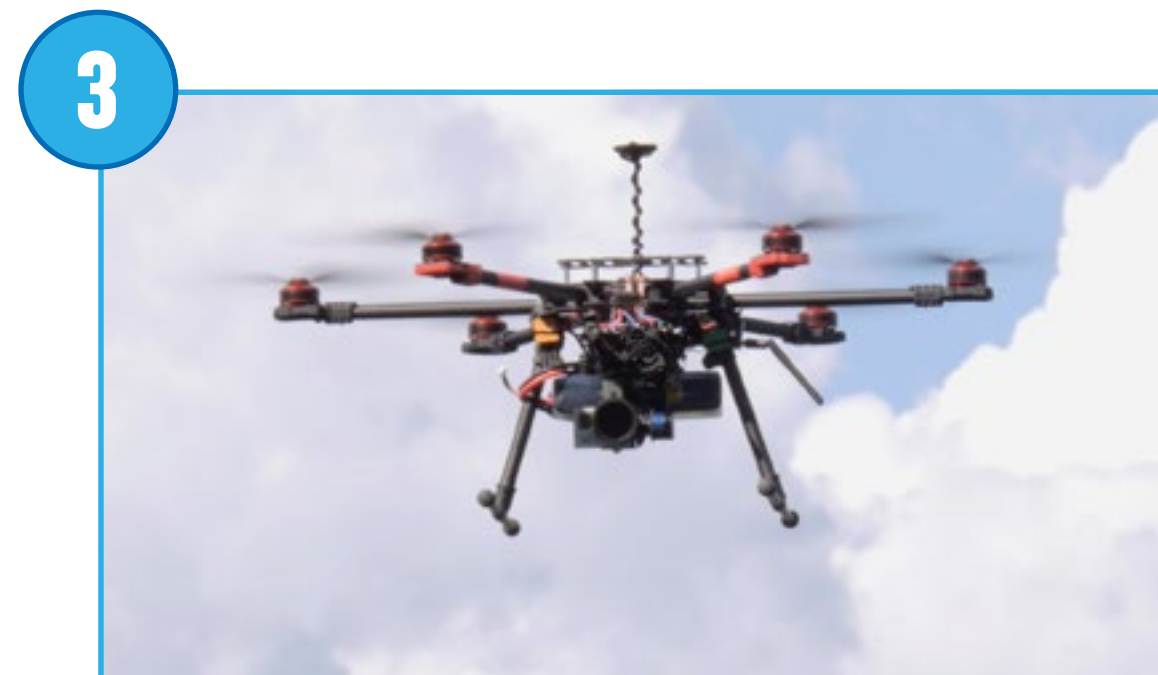
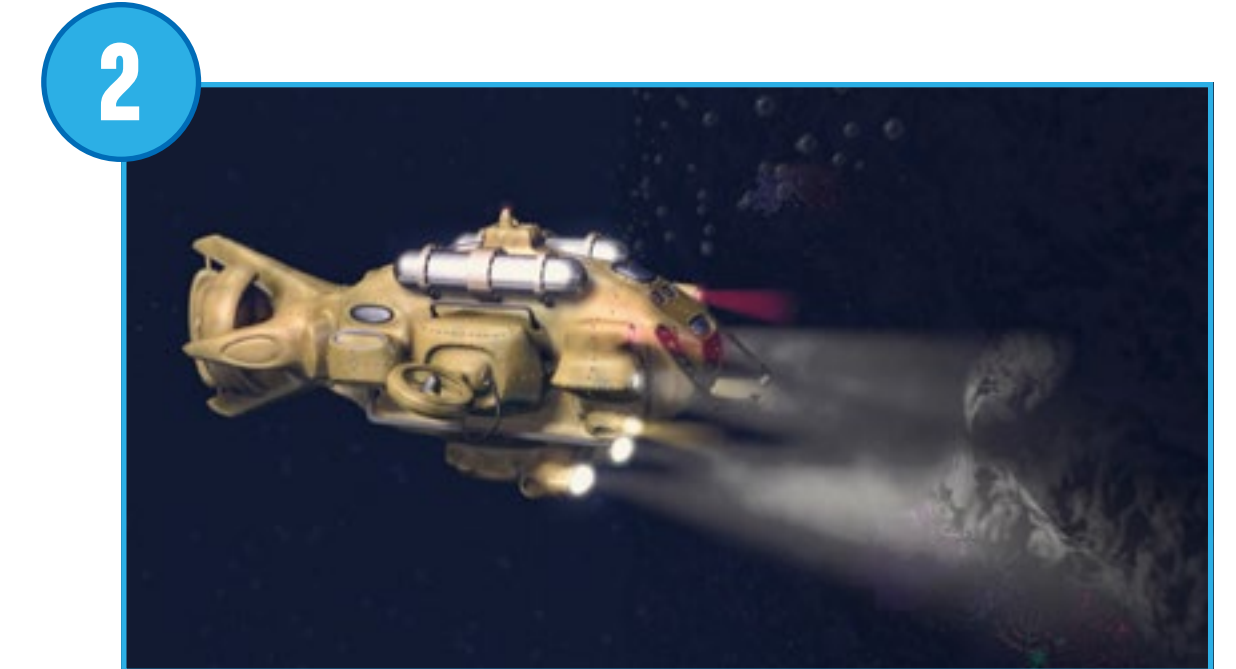



Create phase

Build and program Milo

Students should follow the building instructions to build Milo, the Science Rover.

1. Build Milo, the Science Rover.

This model will give students a “first build” experience with WeDo 2.0.

▶ Important

Make sure everyone can connect the motor to the Smarthub and can connect the Smarthub to the device.

2. Program Milo.

This program will start the motor at power 8, go in one direction for 2 sec., and then stop.

The motor can be started in both directions, stopped and turned at different speeds, and activated for a specific amount of time (specified in seconds).

▶ Suggestion

Give students time to change the parameters of this program string.
Let them discover new features, such as adding sound.

Use this opportunity to guide students to the Design Library so they can gain inspiration about other program strings they can explore.





Share phase

Present

Before you move on to the next part of the Getting Started Project, allow the students to express themselves:

- Have a short discussion with your students about scientific and engineering instruments.
- Have your students describe how science rovers are helpful to humans.

Document

- Have students discover the use of the Documentation tool.
- Have them take a team picture with their model.

Getting Started Project, part B

Milo's Motion Sensor

In this section, students will be introduced to the use of the Motion Sensor to detect the presence of a special plant specimen.





Using a Motion Sensor

Explore phase

When rovers are sent to a remote location, they need to have sensors so they can achieve a task without constant human control.

Questions for discussion

1. How is the use of science instruments important to the task scientists have to do?

When a rover is in a remote place, it needs to have sensors in order to help it make decisions about where to go and where to stop.

Create phase

With the provided building instructions, your students will build an arm using the Motion Sensor that will allow Milo to detect the plant sample. They will also build a plant sample on a LEGO® round plate.

The program string provided will make the rover go forward until it detects the presence of this sample object. It will stop and make a sound.

Use this opportunity to have students record their own sound for the discovery.

Share phase

In this part of the Getting Started Project, ask your students to record a video of their mission. They will practice manipulating the camera and recording themselves, which will be useful in future projects.



Getting Started Project, part C

Milo's Tilt Sensor

In this section, students will be introduced to the use of the Tilt Sensor to help Milo send a message to the base.

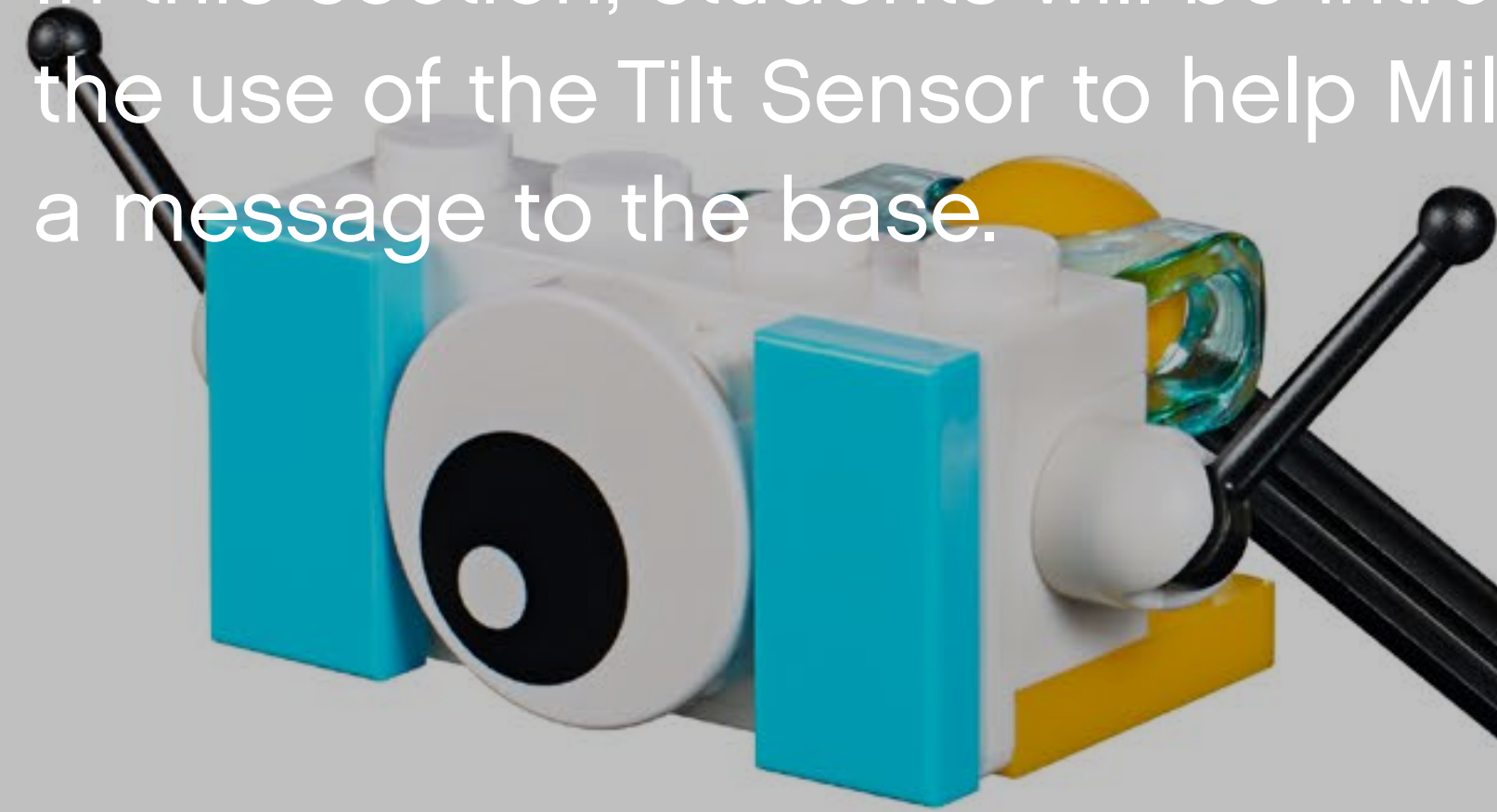



Introduce the use of a Tilt Sensor

Explore phase

When rovers locate what they are looking for, they send a message back to the base.

Questions for discussion

1. Why is communication between a rover and the base important?
If a rover is successful in its mission but fails to send back the results, the whole mission will be worth nothing. Communication remains to link between the remote mission and the base.
2. What are some ways you might communicate with rovers?
Currently satellites are used to send radio signals between the base and the rover.

Create phase

With the provided building instructions, your students will build a device using the Tilt Sensor that can send a message back to the base.

The program string will trigger two actions depending on the angle detected by the Tilt Sensor:

- If tilted down, the red LED will light up.
- If tilted up, a text message will appear on the device.

Share phase

In this section of the Getting Started Project, ask your students to take a screen capture of their final program. Have them practice documenting the program strings they used in their project.



Getting Started Project, part D

Collaborate

In this section, students will be introduced to the importance of collaborating during projects.

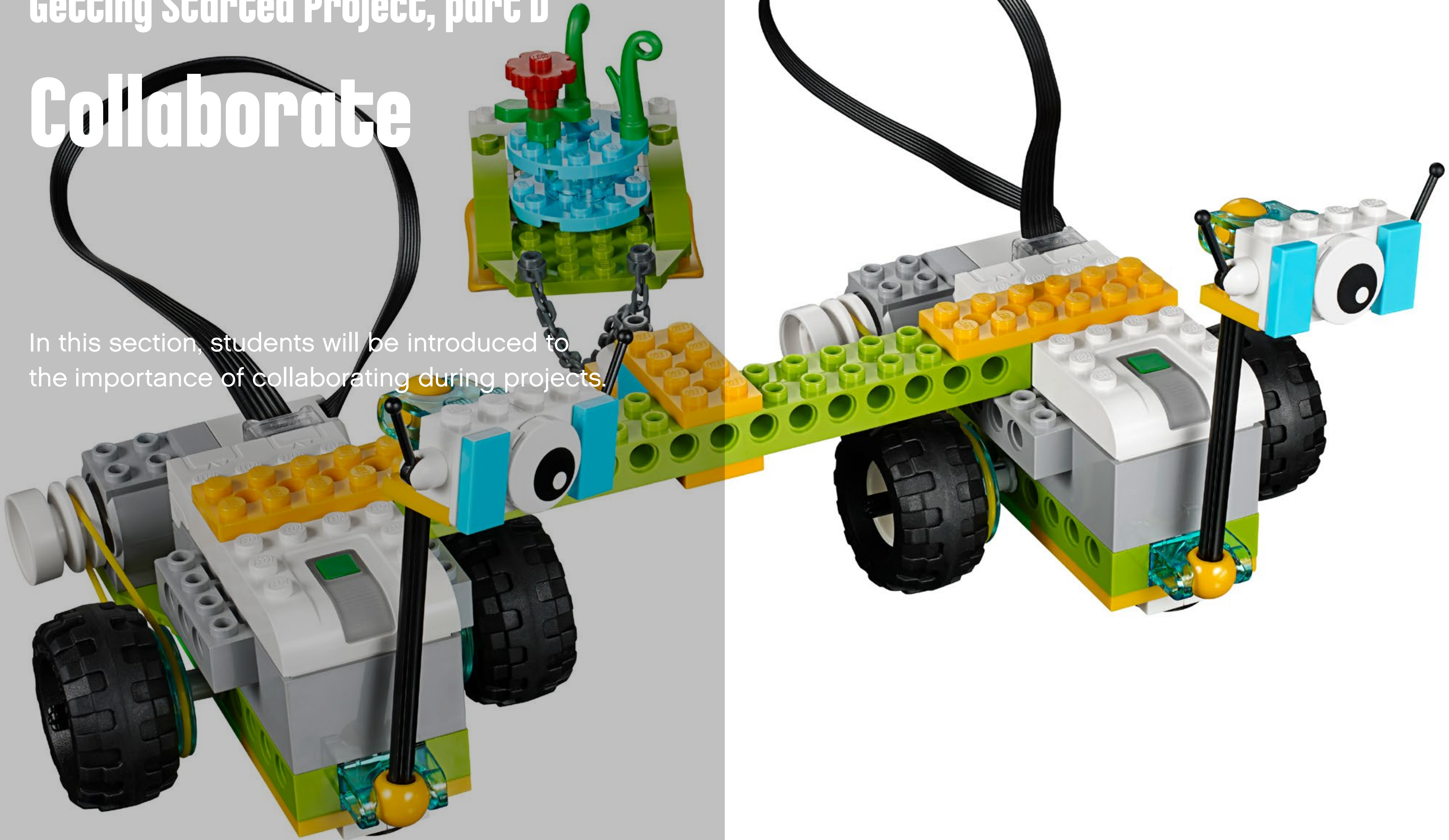



Collaborate with other rovers

Explore phase

Now that your rover has found the plant sample, it is time to carry it back. But wait. It might be too heavy! Let's see if you can collaborate with another rover to move the sample forward together.

Create phase

Pair up the teams to complete this final part of the mission:

1. Have them build the transportation device, physically connecting the two rovers together.
2. Let students create their own program strings so they can move the specimen from point A to B. It doesn't matter where point A or B is.
Students could use the following program strings.
3. When everyone is ready, have the team move their plant sample carefully.

▶ Suggestion

For teams working on their own, note that you can connect up to three Smarthubs to the same tablet. See the "Toolbox" chapter for instructions on how to do that.

Share phase

Have students talk about their experiences:

- Why is it important to collaborate to solve a problem?
- Give an example of good communication among teams.

Finally, have students complete their document with the Documentation tool while collecting and organizing important information.

▶ Important

Because not all the WeDo motors are the same, teams will have to collaborate in order to succeed.



Guided Projects overview

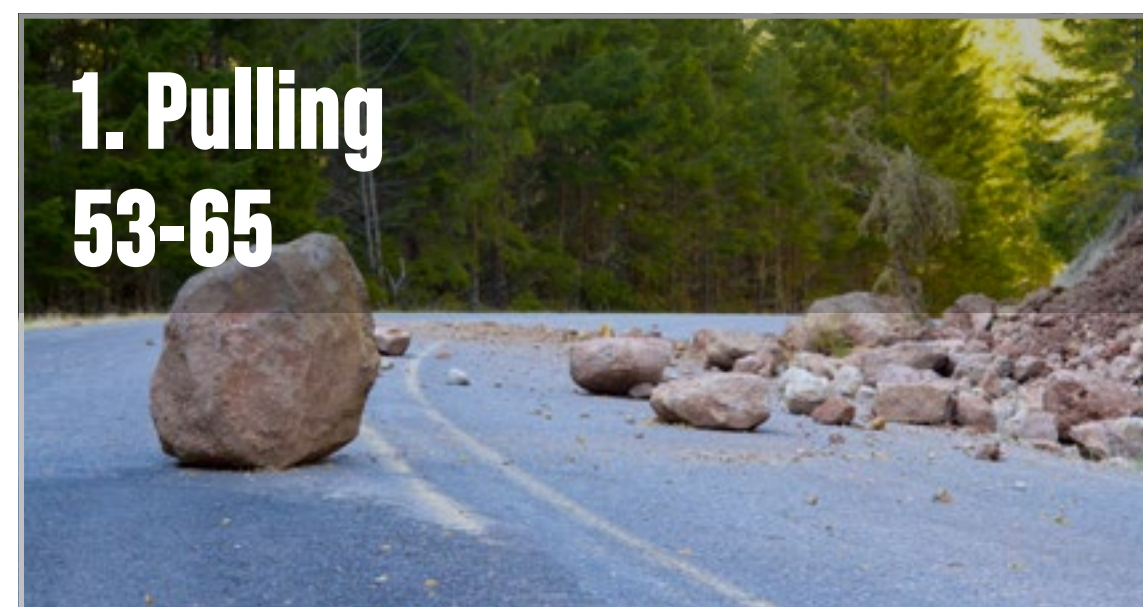

Project 1

Pulling

This project is about investigating the effects of balanced and unbalanced forces on the movement of an object.





Curriculum link

NGSS performance expectation

3-PS2-1: Plan and conduct an investigation to provide evidence of the effects of balanced and unbalanced forces on the motion of an object.

Common Core State Standards for English Language Arts

CCSS.ELA-Literacy.W.3.7: Conduct short research projects that build knowledge about a topic.

CCSS.ELA-Literacy.W.3.8: Recall information from experiences or gather information from print and digital sources; take brief notes on sources and sort evidence into provided categories.

CCSS.ELA-Literacy.SL.3.1.a: Come to discussions prepared, having read or studied required material; explicitly draw on that preparation and other information known about the topic to explore ideas under discussion.

CCSS.ELA-Literacy.SL.3.1.d: Explain your own ideas and comprehension in light of the discussion.





Quick glance: Plan this WeDo 2.0 project

Preparation: 30 min.

- Read the general preparation in the “Classroom Management” chapter.
- Read about the project so you have a good idea of what to do.
- Define how you want to introduce this project: Use the video provided in the project in the WeDo 2.0 Software, or use material of your own choice.
- Determine the end result of this project: the parameters to present and produce the document.
- Make sure timing allows for expectations to be met.

► Important

This project is an investigation; please refer to the “WeDo 2.0 in Curriculum” chapter for further explanations of investigative practices.

Explore phase: 30–60 min.

- Start the project using the introductory video.
- Have a group discussion.
- Allow students to document their ideas for Max and Mia’s questions using the Documentation tool.

Create phase: 45–60 min.

- Get students to build the first model from the provided building instructions.
- Let them program the model with the sample program.
- Allow time for them to test different combinations with different objects. Make sure to explain what is happening in terms of balanced and unbalanced forces.

Create more phase (optional): 45–60 min.

- If you want, use this extra layer of the project for differentiation or for older students.

Share phase: 45 min. or more

- Make sure your students document the results of each test.
- Have students share what they notice based on the evidence gathered during their investigations.
- Ask them to predict the outcome resulting from the addition of weight.
- Have your students create their final presentations.
- Use different ways to let students share results.
- Have students present their project.

► Suggestion

Have a look at the following Open Projects after this one:

- [Cleaning the Oceans](#)
- [Space Exploration](#)



Differentiation

It is recommended that you start with this project.

To ensure success, consider giving more guidance on building and programming, such as:

- Explain the use of motors.
- Explain simple program strings.
- Explain how to conduct an investigation.
- Define factors to focus on, such as pull and friction forces.

Also, be specific on the way you would like them to present and document their findings (think about having a sharing session among teams, for example).

Investigate more

As an added challenge, allow extra time for experimentation with student-created design, building, and programming. This will allow them to explore the additional laws of push and pull.

Also, to investigate more, ask your students to compare the strength of their robots by pairing them in a tug-of-war contest. Be ready for excitement!

Students' misconceptions

Students are likely to believe that if something is not moving, there are no forces acting on it. A good example to bring up is when you try to move a car with the hand brake on. Because the car does not move, students think no force is involved, yet there is. Scientifically, it's understood that several balanced forces are at work.

Vocabulary

Force

Push or pull upon an object

Net force

Overall force acting on an object

Friction

The resisting force when two objects are in contact

Static friction

Force that occurs when two objects are not moving relative to one another (example: desk on a floor)

Rolling friction

Force that occurs when one object rolls on another (example: car wheels on a road)

Kinetic friction or sliding friction

Force that occurs when two objects are moving relative to each other and rub together (example: a sled on snow)

Equilibrium

It is the condition in which all forces are balanced or canceled by equal opposing forces. In other words, it's when net force equals 0.



NGSS project assessment rubrics

You can use these assessment rubrics with the observation rubrics grid, which you will find in the “Assess with WeDo 2.0” chapter.

Explore phase

During the Explore phase, make sure the student is actively involved in the discussion, asks and answers questions, and correctly uses the terms push and pull, forces, and friction.

1. The student is unable to provide answers to questions or participate in discussions adequately or adequately describe the ideas of push and pull or relate that they are forces.
2. The student is able, with prompting, to provide answers to questions or participate in discussions adequately or with help and describe push and pull as an example of a force.
3. The student is able to provide adequate answers to questions and participate in class discussions or describe push and pull as an example of force.
4. The student is able to extend the explanations in discussion or describe in detail the concept of force with push and pull.

Create phase

During the Create phase, make sure the student is working as part of a team, can make predictions about what should happen, and can use the information collected in the Explore phase.

1. The student is unable to work well on a team, make predictions about what should happen, or use information collected.
2. The student is able to work on a team and predict, with help, what might happen in the investigation.
3. The student is able to collect and use information with guidance, work on a team and contribute to the team discussions, make predictions, and collect information to use in a presentation to explain the content.

4. The student is able to work on a team, serve as the leader, and justify predictions to explain the forces of push and pull with information.

Share phase

During the Share phase, make sure the student can explain what is happening with the model in terms of force, has tested different combinations and could predict other ones, and can use important information from their project to create a final report.

1. The student is unable to engage in the discussion about the investigation, explain the model using the concept of force, or use the information to create a final project.
2. The student is able, with prompting, to engage in the discussion about forces, complete multiple testing scenarios in order to make predictions, and use limited information to create a final project.
3. The student is able to engage in discussions about forces investigation and use the information gathered from testing to produce a final project.
4. The student is able to engage extensively in class discussions about the topic and use the information gathered to create a final project that includes additional required elements.



ELA project assessment rubrics

You can use these assessment rubrics with the observation rubrics grid, which you will find in the “Assess with WeDo 2.0” chapter.

Explore phase

During the Explore phase, make sure the student can effectively explain his/her own ideas and comprehension related to the questions posed.

1. The student is unable to share his/her ideas related to the questions posed during the Explore phase.
2. The student is able, with prompting, to share his/her ideas related to the questions posed during the Explore phase.
3. The student adequately expresses his/her ideas related to the questions posed during the Explore phase.
4. The student uses details to extend explanations of his/her ideas related to the questions posed during the Explore phase.

Create phase

During the Create phase, make sure the student makes appropriate choices (i.e., screen capture, image, video, text) and follows the established expectations for documenting findings.

1. The student fails to document findings throughout the investigation.
2. The student gathers documentation of his/her findings, but documentation is incomplete or does not follow all of the expectations established.
3. The student adequately documents findings for each component of the investigation and makes appropriate choices in selections.
4. The student uses a variety of appropriate methods for documentation and exceeds the established expectations.

Share phase

During the Share phase, make sure the student uses evidence from his/her own findings during the investigation to justify his/her reasoning and adheres to established guidelines for presenting findings to the audience.

1. The student does not use evidence from his/her findings in connection with ideas shared during the presentation or does not follow established guidelines.
2. The student uses some evidence from his/her findings, but the justification is limited. Established guidelines are generally followed but may be lacking in one or more areas.
3. The student adequately provides evidence to justify his/her findings and follows established guidelines for presenting.
4. The student fully discusses his/her findings and thoroughly utilizes appropriate evidence to justify his/her reasoning while following all established guidelines.



Explore phase

The introductory video may set the stage for the following ideas to be reviewed and discussed with students for this project.

Introductory video

It has been a long time since humans first tried to move large objects around. From ancient civilizations to the modern age, various tools have been used to push or pull objects.

1. When you do not succeed in pulling something, it is because it is being pulled in the opposite direction with the same or a greater force.
2. When an object starts to move, this means a force is greater in the direction of the movement.
3. On earth, friction has a role to play in this system.
4. On a surface with less friction, it will be easier to pull the same weight than if it is on a rough surface.

This topic about force and motion was explored and explained in detail by Sir Isaac Newton in the 17th century. You experience the laws of physics he defined on a daily basis.

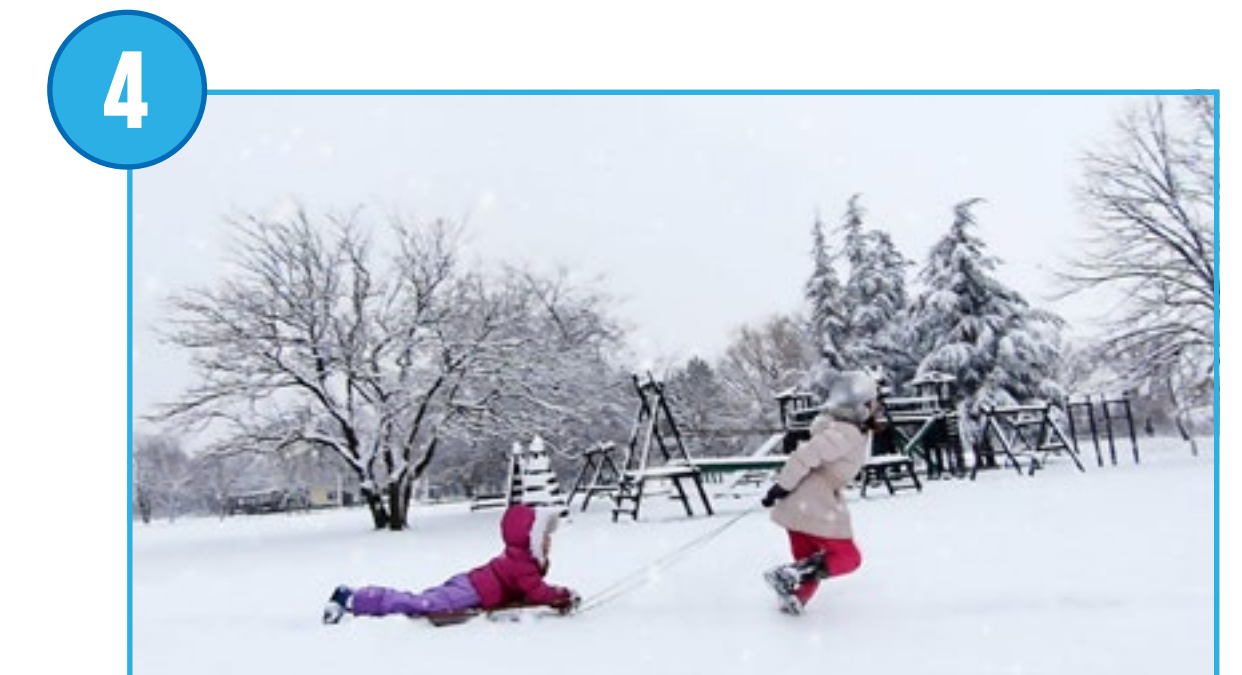



Explore phase

Questions for discussion

1. What are some ways you can make an object move?
To make it move, pull or push it, or, more generally, apply a force to it.
2. Can you explain friction? Is it easier to pull something on a normal surface than on a slippery one?
This question refers to friction. It is easier to move an object on a slippery surface than on a rough one.
Depending on the mass of an object, it can also be more difficult to move the object on a slippery surface because there is less grip to push or pull.
3. Predict what will happen if the pull force is greater in one direction than the other.
This answer should be based upon students' predictions in the beginning.
This means that at this point, your students' answers can be incorrect.
Following the lesson, students should be able to discuss the fact that the motion of the object will be in the direction of the greatest push or pull force.

Have your students collect their answers with text or pictures in the Documentation tool.

Other questions to explore

1. Can you infer the relationship among balanced forces and the objects' ability to move?
Unbalanced forces can cause a change in an object's motion (speeding up, slowing down, etc.)



Create phase

Build and program a Pull-robot

Students will follow the building instructions to create a Pull-robot. This Pull-robot will pull some objects placed in his basket. This investigation can be done on various types of surfaces, like wood or carpet. Use the same surface during the entire project.

1. Build a Pull-robot.

The wobble module used in the project uses a bevel gear. This bevel gear changes the axis of rotation, from vertical to horizontal, bringing the motion from the motor to the wheels.

The basket has some sliding bricks to reduce friction.

2. Program the robot to pull.

This program will display numbers 3, 2, 1 before the motor turns on for 2 sec. at motor power 10.

Suggestion

Before your students start their investigation, have them change the parameters of the program so they fully understand it.





Create phase

Test the Pull-robot

Using this model, students should be able to conduct an investigation about pull forces.

1. Investigate by adding small objects and then heavy objects to the basket until the device stops moving.

It will take around 11 oz. (300 g) on a regular surface to stop the Pull-robot from moving. Students can use any object, but each one should not be too heavy, as the goal of this part is to reach equilibrium. At that point, students have balanced forces in front of them. You can use an arrow to symbolize the direction of the force.

You can also use the small tires as objects to place in the basket. They will increase the friction on the basket side.

2. Using the same amount of bricks, put the big tires on the model and test what happens.

Students will put tires on the Pull-robot. This will cause the friction among the wheels and the surface to be greater on the Pull-robot side, increasing the force pulling in that direction. The system will suddenly become unbalanced.

This evidence supports the idea that when the pull force is greater than the forces opposing it, objects should move.

3. Find the heaviest object you can pull with your model when fitted with the tires.

This final step will depend on the friction of the surface the students are working on.





Create phase

Use the “Investigate more” section of the student project as an optional extension. Keep in mind that these tasks extend upon those in the “Investigate” section and are designed for older or more advanced students.

Investigate more

The Pull-robot that students are working with uses a bevel gear mechanism to change the direction of the motor rotation. It does not greatly increase the strength of the movement.

1. Build a different Pull-robot.

Let students explore new designs for a pull machine. Let them build their own model, do the same tests as with their original Pull-robot and compare the findings of the two investigations. For inspiration, look in the Design Library.

Collaboration suggestion

Find the strongest machine in the classroom

When you think your teams are done testing, organize a tug-of-war contest:

- Pair up two teams.
- Attach the robots back-to-back with the LEGO® chain.
- Have teams place equal amounts of weight and mass in the basket prior to the contest.
- Have them start their engine at your signal, so that they pull away from each other. Which is the strongest?





Share phase

Complete the document

Have students document their project in a range of ways (suggestions may include):

- Ask them to take a screen capture of their results.
- Get them to compare these images with real-life images.
- Invite students to record a video of them describing their project to the class.

▶ Suggestions

Students may collect data in a chart format or on a spreadsheet.

Students may also graph the results of their tests.

Present results

At the end of this project, students should present the result of their investigation.

To enhance your students' presentation:

- Make sure students use words like balanced force, unbalanced force, push, pull, friction, and weight.
- Ask them to use arrows to represent force.
- Ask them to put their explanation in context.
- Ask them to analyze their projects in terms of real-life situations in which they have observed balanced and unbalanced forces.
- Discuss the connection among their findings and these particular situations.

Pulling

One possible way of sharing

Students explain the maximum weight that they could pull and whether the force is balanced or unbalanced.

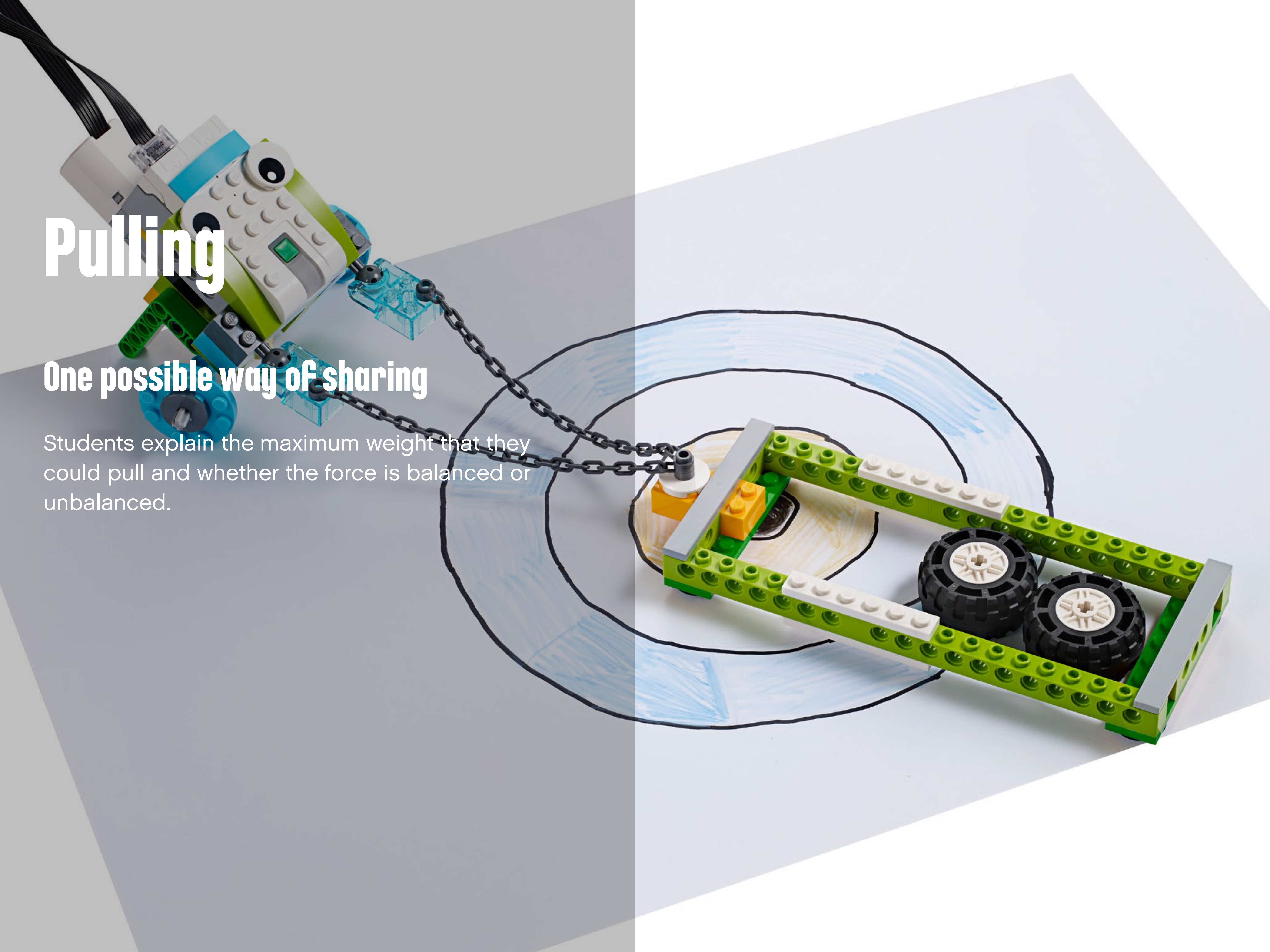

Project 2

Speed

This project is about investigating what factors can make a car go faster to help predict future motion.





Curriculum link

NGSS performance expectation

3-PS2-2: Make observations and/or measurements of an object's motion to provide evidence that a pattern can be used to predict future motion.

4-PS3-1: Use evidence to construct an explanation relating the speed of an object to the energy of that object.

NGSS crosscutting concepts

Patterns

Common Core State Standards for English Language Arts

CCSS.ELA-Literacy.SL.3.1.a: Come to discussions prepared, having read or studied required material; explicitly draw on that preparation and other information known about the topic to explore ideas under discussion.

CCSS.ELA-Literacy.SL.3.1.d: Explain their own ideas and comprehension in light of the discussion.

CCSS.ELA-Literacy.W.3.8: Recall information from experiences or gather information from print and digital sources; take brief notes on sources and sort evidence into provided categories.

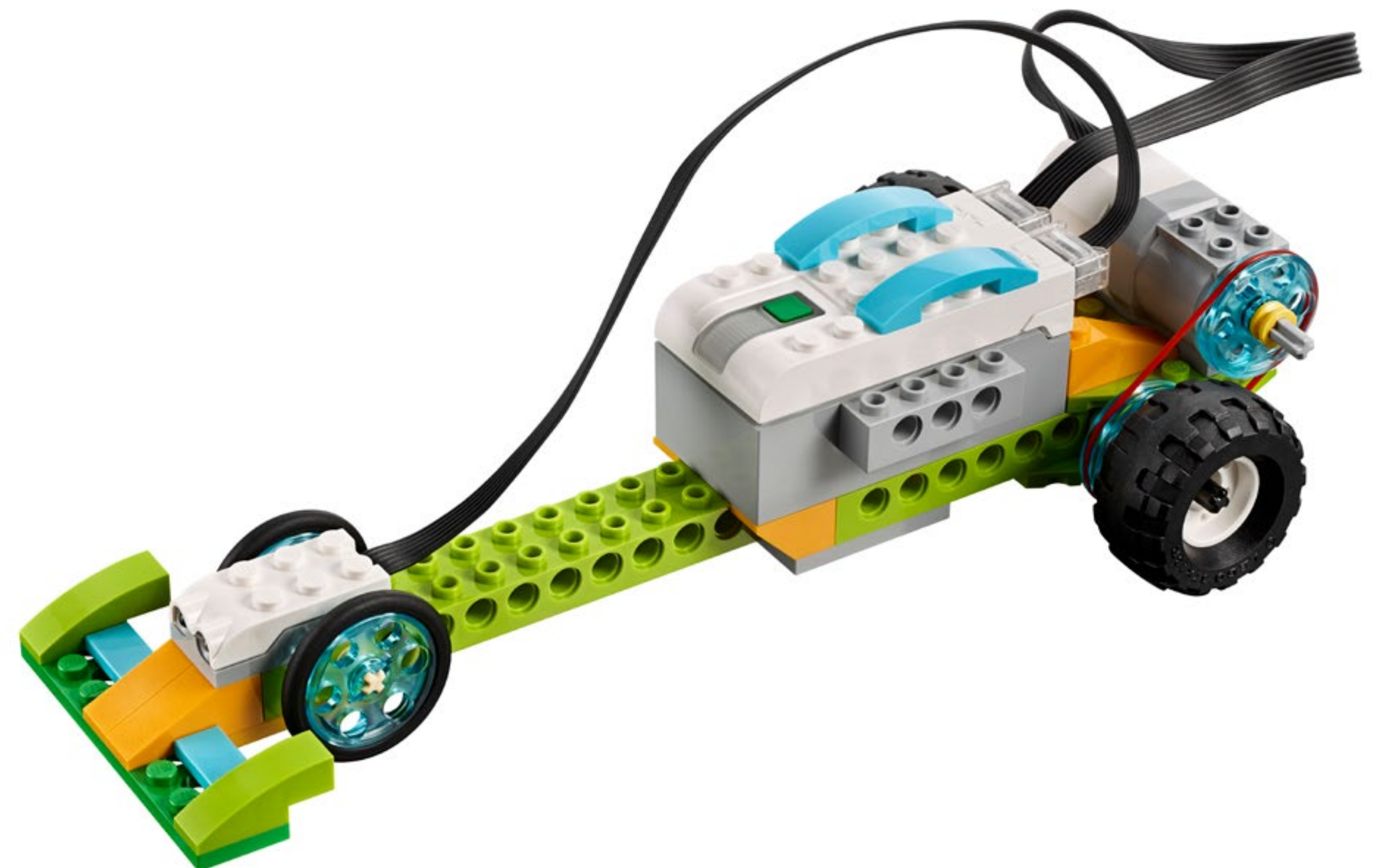



Quick glance: Plan this WeDo 2.0 project

Preparation: 30 min.

- Read the general preparation in the “Classroom Management” chapter.
- Read about the project so you have a good idea of what to do.
- Define how you want to introduce this project: Use the video provided in the project in the WeDo 2.0 Software, or use material of your own choice.
- Determine the end result of this project: the parameters to present and produce the document.
- Make sure timing allows for expectations to be met.

► Important

This project is an investigation; please refer to the “WeDo 2.0 in Curriculum” chapter for further explanations of investigative practices.

Explore phase: 30–60 min.

- Start the project using the introductory video.
- Have a group discussion.
- Allow students to document their ideas for Max and Mia’s questions using the Documentation tool.

Create phase: 45–60 min.

- Get students to build the first model from the provided building instructions.
- Have students use a minimum distance of 2.5 yd. (2 m or more). Be sure to have students mark their starting point and set up a barrier that will cause the car to stop.
- Let them program the model with the sample program.
- Allow time for them to test the different combinations to make the car go faster.

Create more phase (optional): 45–60 min.

- If you want, use this extra layer of the project for differentiation or for older students.

Share phase: 45 min. or more

- Make sure your students document the results of each test.
- Have students share what they notice based on the evidence gathered during their investigations.
- Ask them to predict the pattern resulting from doubling the distance.
- Have your students create their final presentations.
- Use different ways to let students share results.
- Have students present their project.

► Suggestion

Have a look at the following Open Projects after this one:

- [Space Exploration](#)
- [Moving materials](#)



Differentiation

To ensure success, consider giving more guidance on building and programming, such as:

- Explain how to conduct an investigation.
- Define factors your students will focus on, such as the size of wheels, motor power, or type of pulley setting.

Also, be specific in establishing expectations for students to present and document their findings.

Investigate more

As an added challenge, allow extra time to investigate with student-created designs and programs. This will allow them to explore additional factors that influence speed.

Students' misconceptions

Students often have trouble distinguishing between speed and acceleration. A common misconception held by learners is the idea that if speed is constant, then acceleration is also constant. Speed and acceleration are two different concepts that are linked to each other, but if there is no change in the speed, then there is no acceleration or deceleration.

Vocabulary

Speed

Speed is the measurement of how fast an object moves in relation to a point of reference. Speed is calculated by dividing distance over time.

Acceleration

Measurement of the change of speed



NGSS project assessment rubrics

You can use these assessment rubrics with the observation rubrics grid, which you will find in the “Assess with WeDo 2.0” chapter.

Explore phase

During the Explore phase, make sure the student is actively involved in the discussions and asking and answering questions and can describe factors that affect speed in cars.

1. The student is unable to adequately provide answers to questions or participate in discussions or describe factors that affect speed.
2. The student is able, with prompting, to adequately provide answers to questions or participate in discussions or, with help, describe factors that affect speed.
3. The student is able to provide adequate answers to questions and participate in class discussions or describe the factors that affect speed, though not in detail.
4. The student is able to extend the explanations in discussions or describe in detail the factors that affect speed.

Create phase

During the Create phase, make sure the student is able to work as part of a team, test one factor at a time to determine its influence on speed, and use the information collected in the Explore phase.

1. The student is unable to work well on a team and complete the testing of each factor affecting speed in order to use the information.
2. The student is able to work in a team and complete the testing, with help, of each factor affecting speed in order to use the information.
3. The student is able to work on a team, contribute to the team discussions, and complete the testing of each factor in order to use the information.
4. The student is able to work on a team, serve as the leader, and extend the testing of factors affecting speed beyond the required elements.

Share phase

During the Share phase, make sure the student can engage in discussions about the investigation, explain their findings, and use important information from their project to create a final report.

1. The student is unable to engage in discussions about the investigation and use the information to create a final project.
2. The student is able, with prompting, to engage in discussions about the investigation and use limited information to create a basic final project.
3. The student is able to engage in discussions about the investigation and use the information gathered to produce a final project.
4. The student is able to engage extensively in class discussions about the topic and use the information gathered to create a final project that includes additional required elements.



ELA project assessment rubrics

You can use these assessment rubrics with the observation rubrics grid, which you will find in the “Assess with WeDo 2.0” chapter.

Explore phase

During the Explore phase, make sure the student can effectively explain his/her own ideas and comprehension related to the questions posed.

1. The student is unable to share his/her ideas related to the questions posed during the Explore phase.
2. The student is able, with prompting, to share his/her ideas related to the questions posed during the Explore phase.
3. The student adequately expresses his/her ideas related to the questions posed during the Explore phase.
4. The student uses details to extend explanations of his/her ideas related to the questions posed during the Explore phase.

Create phase

During the Create phase, make sure the student makes appropriate choices (i.e., screen capture, image, video, text) and follows the established expectations for documenting findings.

1. The student fails to document findings throughout the investigation.
2. The student gathers documentation of his/her findings, but the documentation is incomplete or does not follow all of the expectations established.
3. The student adequately documents findings for each component of the investigation and makes appropriate choices in selections.
4. The student uses a variety of appropriate methods for documentation and exceeds the established expectations.

Share phase

During the Share phase, make sure the student uses evidence from his/her own findings during the investigation to justify his/her reasoning and adheres to established guidelines for presenting findings to the audience.

1. The student does not use evidence from his/her findings in connection with ideas shared during the presentation. The student does not follow established guidelines.
2. The student uses some evidence from his/her findings, but the justification is limited. Established guidelines are generally followed but may be lacking in one or more areas.
3. The student adequately provides evidence to justify his/her findings and follows established guidelines for presenting.
4. The student fully discusses his/her findings and thoroughly utilizes appropriate evidence to justify his/her reasoning while following all established guidelines.



Explore phase

The introductory video may set the stage for the following ideas to be reviewed and discussed with students for this project.

Introductory video

Here are some suggested talking points for the video:

1. Cars allow us to move from one point to another faster. But there was once a time when cars were slower than horses.
2. In a quest for improvement, car engineers searched for elements that could influence a car's speed.
3. Engineers looked at all parts of the car to design stronger engines and mechanisms.
4. Engineers improved the wheels and tires and changed the size and materials.
5. Today, cars can go as fast as 250 mph (400 km/h).





Explore phase

Questions for discussion

Use these questions prior to and following the lesson.

1. What are some ways that cars have been improved to become faster?
There are many factors that can influence the speed of a car. Size of the wheels, motor power, gears, aerodynamics, and weight would be the most common ones. The color of the car, brand, or driver experience should not be considered as potential elements for study.
2. What elements can influence the time required for a car to travel a certain distance as fast as possible?
This answer should provide prior knowledge regarding comprehension of the content. This means that at the beginning of the lesson, students' answers can be incorrect. However, by the end of the lesson, students should be able to provide an accurate answer to the question.

Additionally, you may want to have students respond to these questions with text or pictures in the Documentation tool following the lesson.

Other questions to explore

1. What can you infer about the relationship between wheel size and the time it takes the car to move a distance?
The bigger the size of the wheel is, the faster the car will travel the distance, if all the other parameters are kept constant.
2. What did you notice about the configuration of the pulley and its effect of the car's speed over the distance?
One of the pulley configurations makes the car go faster and the other reduces the speed of the car.
3. How can you measure the speed of an object?
Speed is measured by dividing the time required to travel a distance by the measure of that distance. A unit of speed is always distance for a specific period of time.



Create phase

Build and program a race car

Students will follow the building instructions to create a race car. These types of vehicles are optimized to go as fast as possible.

1. Build a race car.

The drive module used in this project uses a pulley. This pulley system can be assembled in two different positions: the reduced speed position (small pulley and large pulley) or the normal speed position (large pulley to large pulley).

2. Program the race car to calculate time.

Students need to have a hand in front of the race car before the start of the program. This program will start by displaying no. 0 and wait for the start signal. When your students remove their hands, the program will turn the motor on, go to maximum power, and repeat, adding no.1 to the display. The loop will repeat until it reaches the end of the race. Then the motor will turn off.

▶ Important

For this program, students need to put their hands in front of the car before they execute the program string. When they remove their hands, the car will start its race.

▶ Important

For this investigation, it is crucial that you have the same setup throughout the test. It is the only way students can isolate one element at a time:

- The start line should always be at the same distance from the finish line, which is a wall or a box.
- The distance between the start and finish line is greater than 2.5 yd. (2 m).





Create phase

Investigate speed factors

From this model, students should be able to test different factors, one at a time. They should test a distance greater than 2.5 yd. (2 m) to see results.

1. Run the race with **SMALL** wheels at motor power 10.

When running this test, students should record the number on the display. They should repeat the test three times to make sure it is consistent.

If the value in one of the three tests is disproportionate, repeat the test for a fourth time. This value is the approximate number of seconds it took for the race car to travel the distance.

2. Run the race with **BIG** wheels at motor power 10.

By changing the wheels, the race car should take less time to travel the same distance, and therefore, have a greater speed. Repeating the test three times will make sure it is consistent. If the value of one of the three tests is disproportionate, repeat the test for a fourth time.

Suggestion

Other options could be considered to reach a more precise result, including increasing the number of trials or finding the average.

3. Predict the time it will take to travel twice the distance.

When the distance doubles and the motor power level and size of tires are the same as the previous test, the number of seconds should also double.



Create phase

Use the “Investigate more” section of the student project as an optional extension as you see fit for your learners. Keep in mind that these tasks extend upon those on the “Investigate” section and are designed for older or more advanced students.

Investigate more speed factors

With the same race car model and the same setup, students can hypothesize and test other factors that may influence the speed of the car.

1. Change the motor power.

Changing the motor power level from no. 10 to no. 5 will make the race car take more time to travel the same distance.

2. Change the drive mechanism (pulley configuration).

Changing the drive mechanism from the normal position to the reduced speed position will make the race car take more time to travel the same distance.

3. Investigate another element.

Have students do the test based on another factor they think could influence the speed of the race car: the width, the length, the height, the weight, or another factor of their own choosing.

Collaboration suggestion

Allow your students time to design and build their own ultimate race cars so that they can apply their findings and make them as fast as possible. Get the teams back together, organize a race, and see whose car is the fastest.

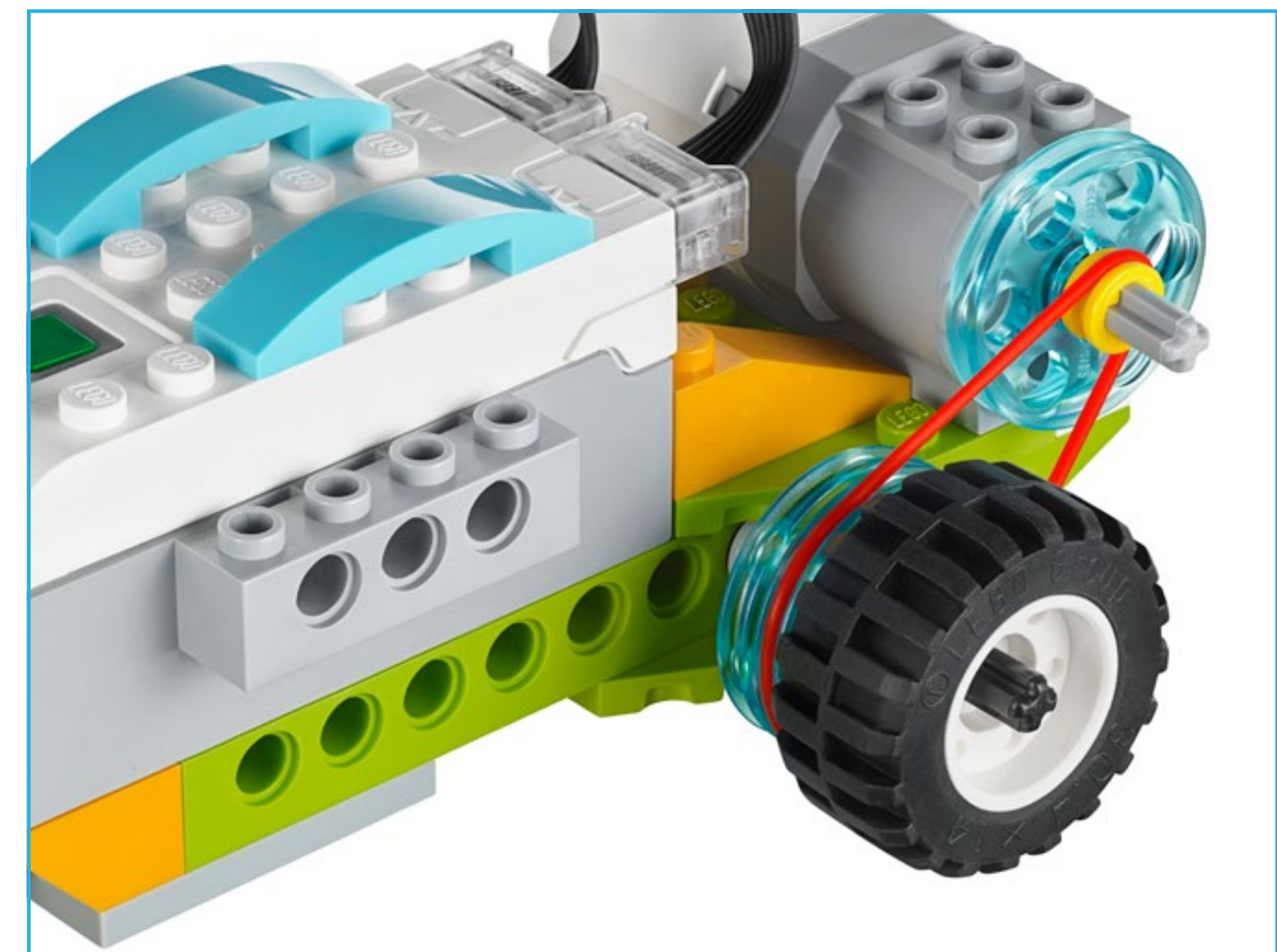
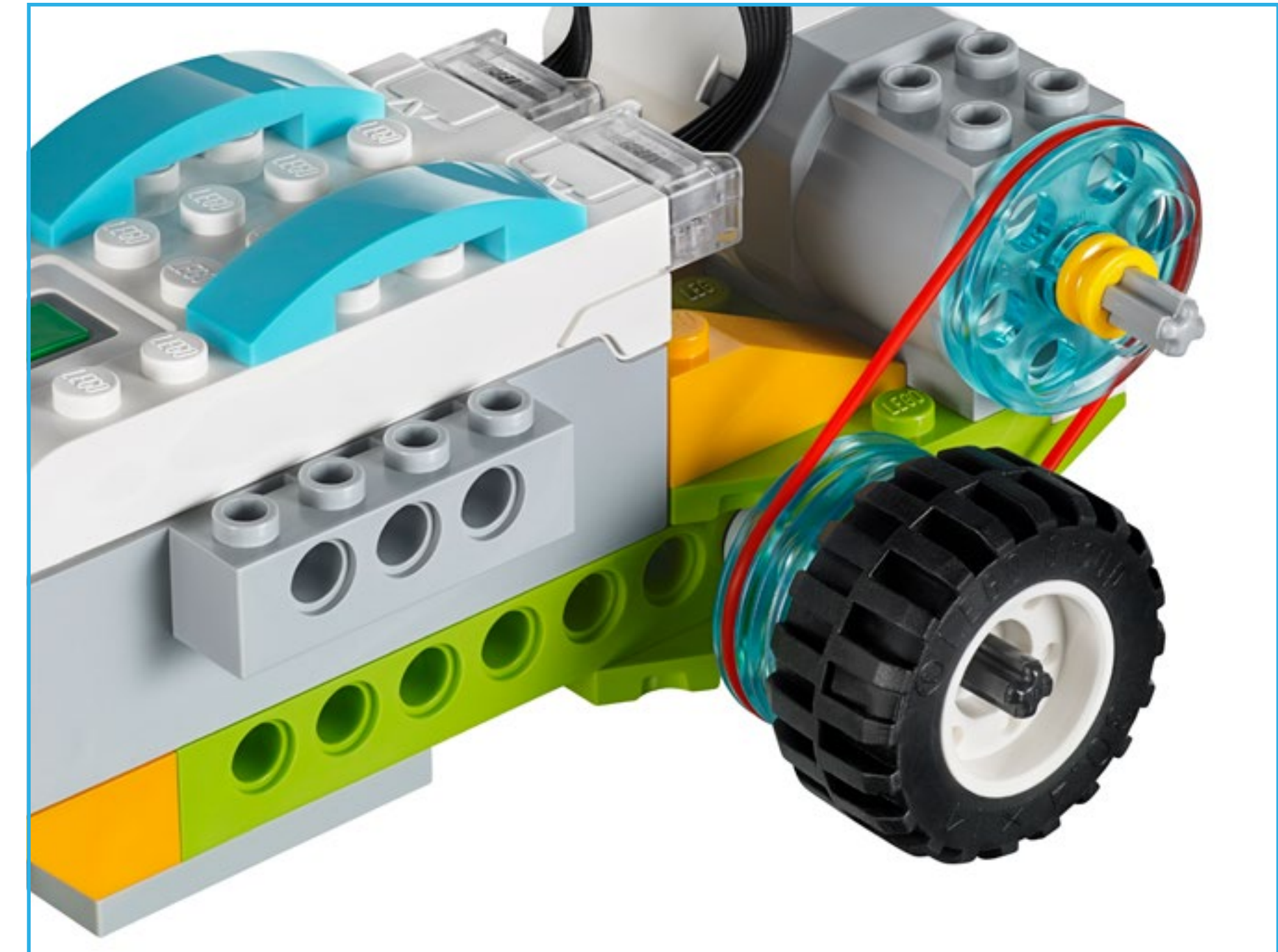



Share phase

Complete the document

Have students document their project in a range of ways (suggestions may include):

- Ask them to take a screen capture of their results.
- Get them to compare these images with real-life images.
- Invite students to record a video of themselves describing their project to the class.

Suggestions

Students may collect data in a chart format or on a spreadsheet.

Students may graph the results of their tests.

Present results

At the end of this project, students should present which elements influence a car's speed. Conclusions should reflect the fact that larger tires, stronger motors, and greater motor power generate much higher speeds.

To enhance students' presentations:

- Ask them to put their explanation in context.
- Ask them to analyze situations in real life in which they have observed speed as an element.
- Discuss the connection among their findings and these particular situations.

Speed

One possible way of sharing

Students in this class investigate the fastest race car by organizing a race.

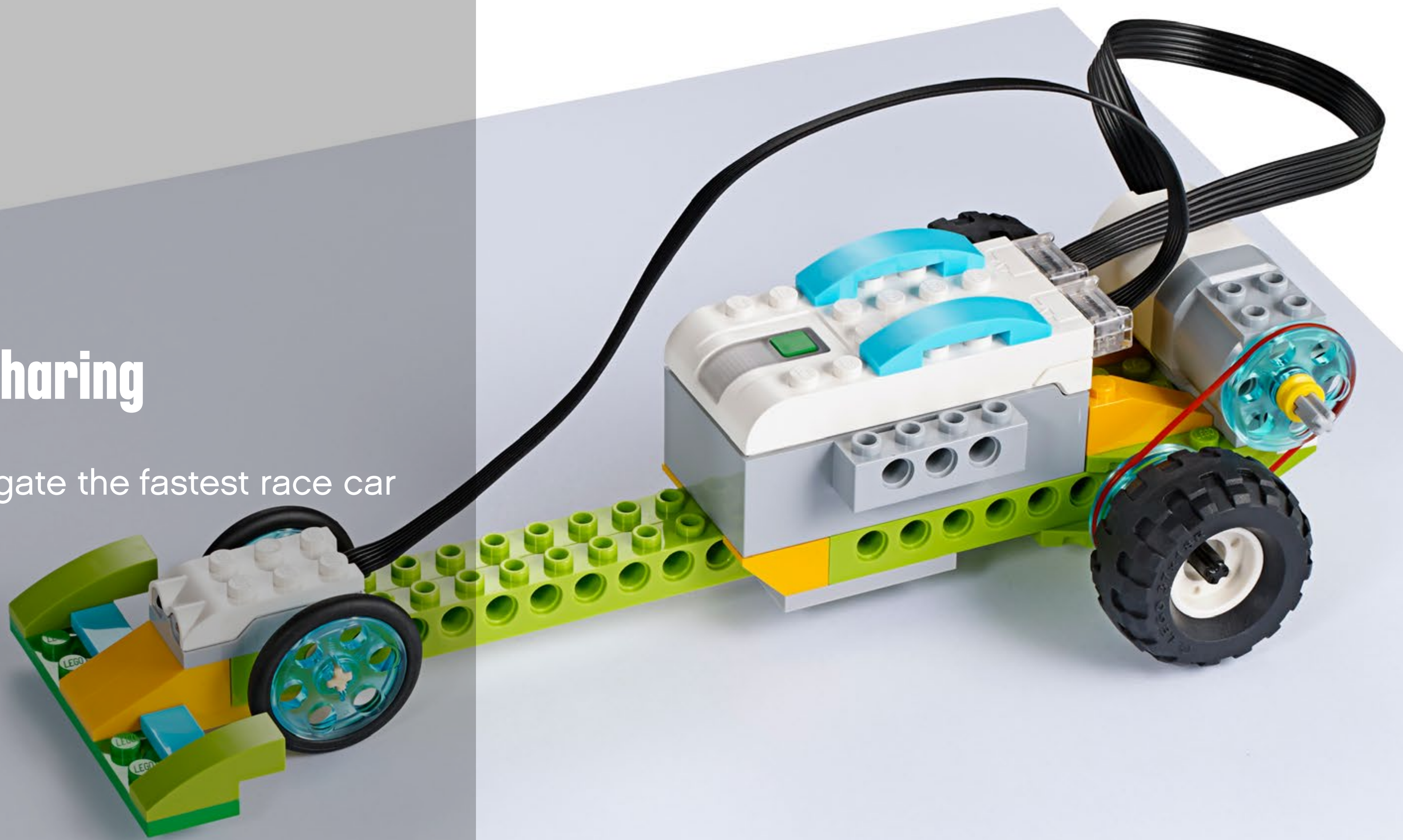

Project 3

Robust Structures

This project is about investigating what characteristics of a building would help make it resistant to an earthquake, using an earthquake simulator constructed from LEGO® bricks.





Curriculum link

NGSS performance expectation

3-5-ETS1-3: Plan and carry out fair tests in which variables are controlled and failure points are considered to identify aspects of a model or prototype that can be improved.

4-ESS3-2: Generate and compare multiple solutions to reduce the impacts of natural earth processes on humans.

NGSS crosscutting concepts

Cause and effect

Common Core State Standards for English Language Arts

CCSS.ELA-Literacy.RI.2.3: Describe the connection among a series of historical events, scientific ideas, or concepts, or steps in technical procedures in a text.

CCSS.ELA-Literacy.RI.4.3: Explain events, procedures, ideas, or concepts in a historical, scientific, or technical text, including what happened and why, based on specific information in the text.

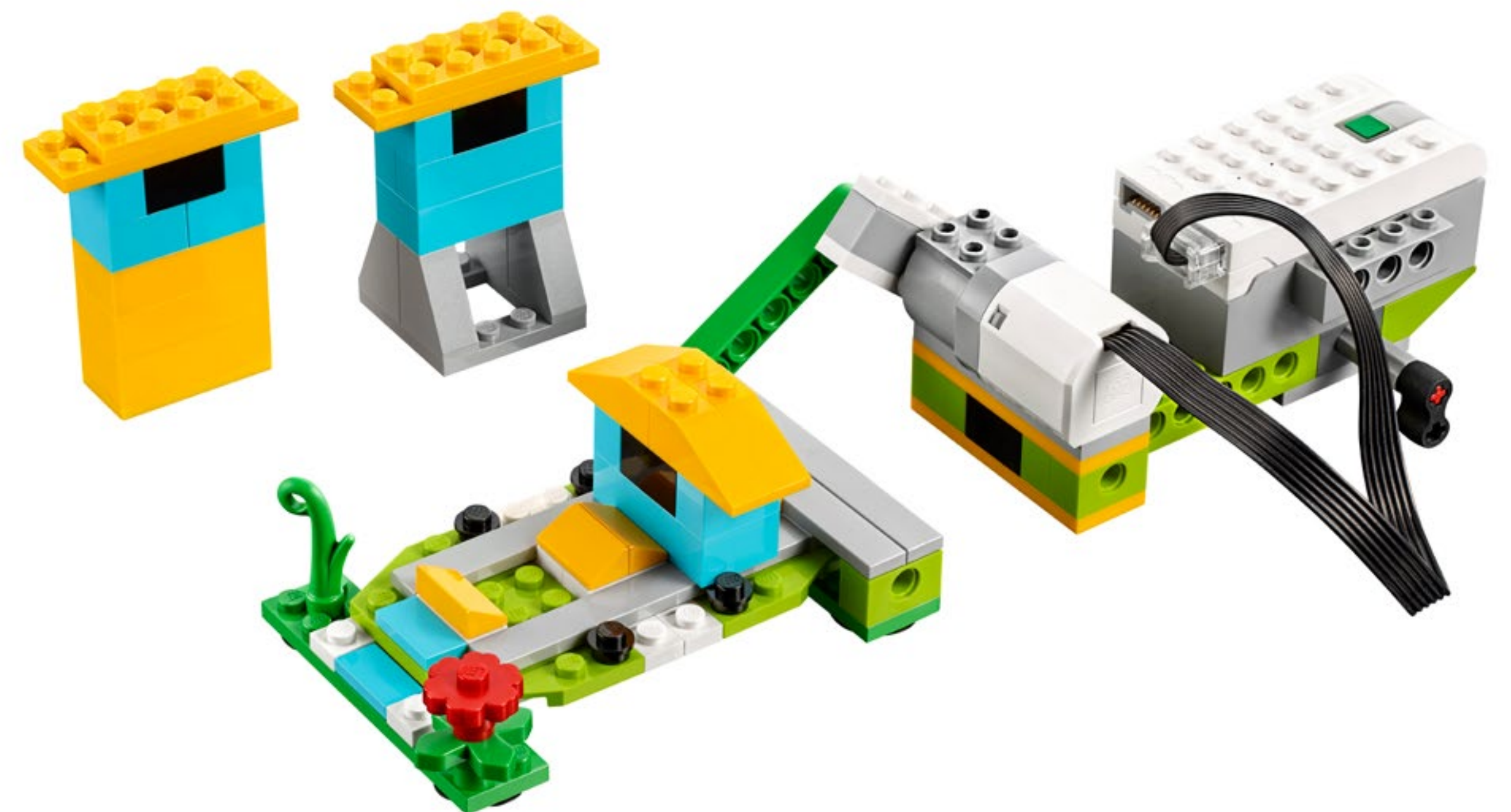



Quick glance: Plan this WeDo 2.0 project

Preparation: 30 min.

- Read the general preparation in the “Classroom Management” chapter.
- Read about the project so you have a good idea of what to do.
- Define how you want to introduce this project: Use the video provided in the project in the WeDo 2.0 Software, or use material of your own choice.
- Determine the end result of this project: the parameters to present and produce the document.
- Make sure timing allows for expectations to be met.

► Important

This project is an investigation; please refer to the “WeDo 2.0 in Curriculum” chapter for further explanations of investigative practices.

Explore phase: 30–60 min.

- Start the project using the introductory video.
- Have a group discussion.
- Allow students to document their ideas for Max and Mia’s questions using the Documentation tool.

Create phase: 45–60 min.

- Get students to build the earthquake simulator and three buildings from the provided building instructions.
- Let them program the model with the sample program.
- Allow time so that students understand how the program works, and give them time to modify the parameters and carry out further tests.

Create more phase (optional): 45–60 min.

- If you want, use this extra layer of the project for differentiation or for older students.

Share phase: 45 min. or more

- Make sure your students document their work when they test different buildings.
- Let students share experiences in different ways.
- Have your students create their final reports and present their projects.

► Suggestion

Have a look at the following Open Projects after this one:

- [Hazard Alarm](#)
- [Moving Materials](#)



Differentiation

To ensure success, consider giving more guidance on building and programming, such as:

- Explain how to conduct an investigation.
- Utilize evidence to construct explanations.
- Offer them additional experiences with isolated variables to test hypotheses.

Also, be specific in establishing expectations for students to present and document their findings.

▶ Suggestion

For more experienced students, allow extra time for building and programming so they can use their own inquiries to design their own investigations. Students could change parameters, such as the level of the earthquake simulator, the materials used to construct the buildings, or the surface on which they test their buildings.

Investigate more

Students will design the tallest building resisting a grade 8 earthquake. They will apply learnings from the previous investigation.

Possible student misconceptions

Students may believe that earthquakes happen in random locations across the earth. Most of the world's seismic activity is associated with tectonic plate boundaries. While shallow crevasses may form during an earthquake, due to landslides or ground failures, the ground does not “open up” along a fault line.

Vocabulary

Earthquake

Ground vibrations produced when earth's tectonic plates slip past each other

Tectonic plates

Big parts of the earth's crust that move relative to each other due to convection currents in the underlying mantle

Richter scale

Logarithmic scale that classifies the level of the energy liberated in an earthquake

Variable

In a scientific experiment, an element that can be manipulated, controlled, or measured

Prototype

Early sample or model that is used to test a concept



NGSS project assessment rubrics

You can use these assessment rubrics with the observation rubrics grid, which you will find in the “Assess with WeDo 2.0” chapter.

Explore phase

During the Explore phase, make sure the student is actively involved in the discussions, asks and answers questions, and can answer in their own words questions about earthquakes.

1. The student is unable to provide answers to questions or participate in discussions adequately.
2. The student is able, with prompting, to provide answers to questions or participate in discussions adequately or, describe elements that may influence a structure’s resistance to earthquakes.
3. The student is able to provide adequate answers to questions, participate in class discussions, and describe elements that may influence a structure’s resistance to an earthquake.
4. The student is able to extend the explanations in discussion and describe in detail the factors that may influence a structure’s resistance to an earthquake.

Create phase

During the Create phase, make sure the students uses documentation to record predictions and findings and changes only one variable at a time as he/she conducts the investigations.

1. The student does not complete all necessary documentation throughout the investigations and rarely exhibits accuracy in changing only one variable at a time during the investigations.
2. The student uses documentation but some critical elements are missing and inconsistently exhibits accuracy in changing only one variable at a time during the investigations.

3. The student uses adequate documentation to record predictions and findings or generally exhibits accuracy in changing only one variable at a time during the investigations.
4. The student uses excellent documentation to record predictions and findings or consistently exhibits accuracy in changing only one variable at a time during the investigations.

Share phase

During the Share phase, make sure the student can effectively utilize documents and verbal communication to explain what is happening with the earthquake simulator and what can be concluded from the results of the tests.

1. The student offers no explanation, neither in his/her document nor through verbal communication.
2. The student ineffectively utilizes documents and verbal communication to explain what is happening and what can be concluded. The explanation may be incomplete or inaccurate.
3. The student effectively utilizes documents and verbal communication to explain what is happening and what can be concluded.
4. The student effectively utilizes documents and verbal communication to offer a sophisticated and accurate explanation of what is happening and what can be concluded.



ELA project assessment rubrics

You can use these assessment rubrics with the observation rubrics grid, which you will find in the “Assess with WeDo 2.0” chapter.

Explore phase

During the Explore phase, make sure the student can effectively explain his/her own ideas and comprehension related to the questions posed.

1. The student is unable to share his/her ideas related to the questions posed during the Explore phase.
2. The student is able, with prompting, to share his/her ideas related to the questions posed during the Explore phase.
3. The student adequately expresses his/her ideas related to the questions posed during the Explore phase.
4. The student uses details to extend explanations of his/her ideas related to the questions posed during the Explore phase.

Create phase

During the Create phase, make sure the student makes appropriate choices (i.e., screen capture, image, video, text) and follows the established expectations for documenting findings.

1. The student fails to document findings throughout the investigation.
2. The student gathers documentation of his/her findings, but the documentation is incomplete or does not follow all of the expectations established.
3. The student adequately documents findings for each component of the investigation and makes appropriate choices in selections.
4. The student uses a variety of appropriate methods for documentation and exceeds the established expectations.

Share phase

During the Share phase, make sure the student uses evidence from his/her own document text and video to explain ideas, including what happened and why.

1. The student does not use evidence from his/her own document text and video and cannot explain ideas, including what happened and why.
2. The student uses some evidence from his/her own document text and video but cannot completely explain ideas, including what happened and why.
3. The student uses evidence from his/her own document text and video to explain ideas, including what happened and why.
4. The student uses a variety of evidence from his/her own document text and video to thoroughly explain ideas, including what happened and why.



Explore phase

The introductory video may set the stage for the following ideas to be reviewed and discussed with students for this project.

Introductory video

Here are some suggested talking points for the video:

1. Since it was formed, the earth has been changing its shape. Like big chunks of cookies getting pushed around on top of a layer of honey, the tectonic plates composing the earth slide, rub past each other, and collide.
2. When doing so, this friction creates vibrations on the surface of the earth where you live.
3. During an earthquake, depending on the strength of the vibrations and a variety of other factors, buildings and other structures may be damaged or destroyed.
4. These days, you are able to build more resistant buildings than even decades ago, thanks to scientific discoveries that have led to improvements in design.

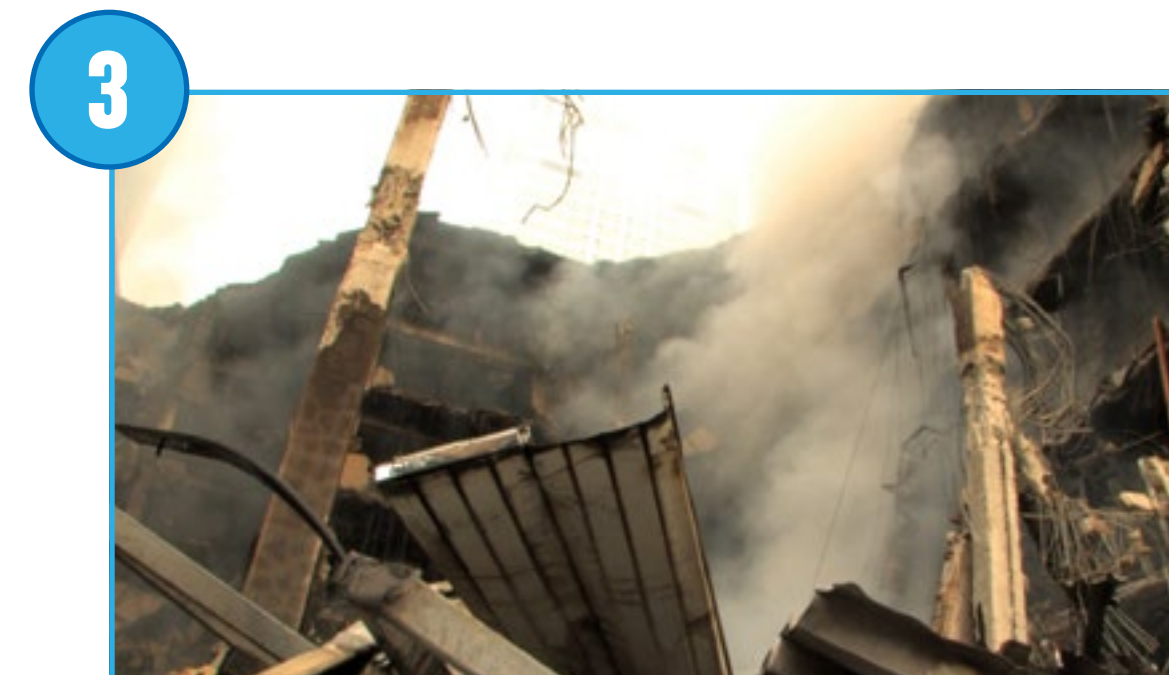
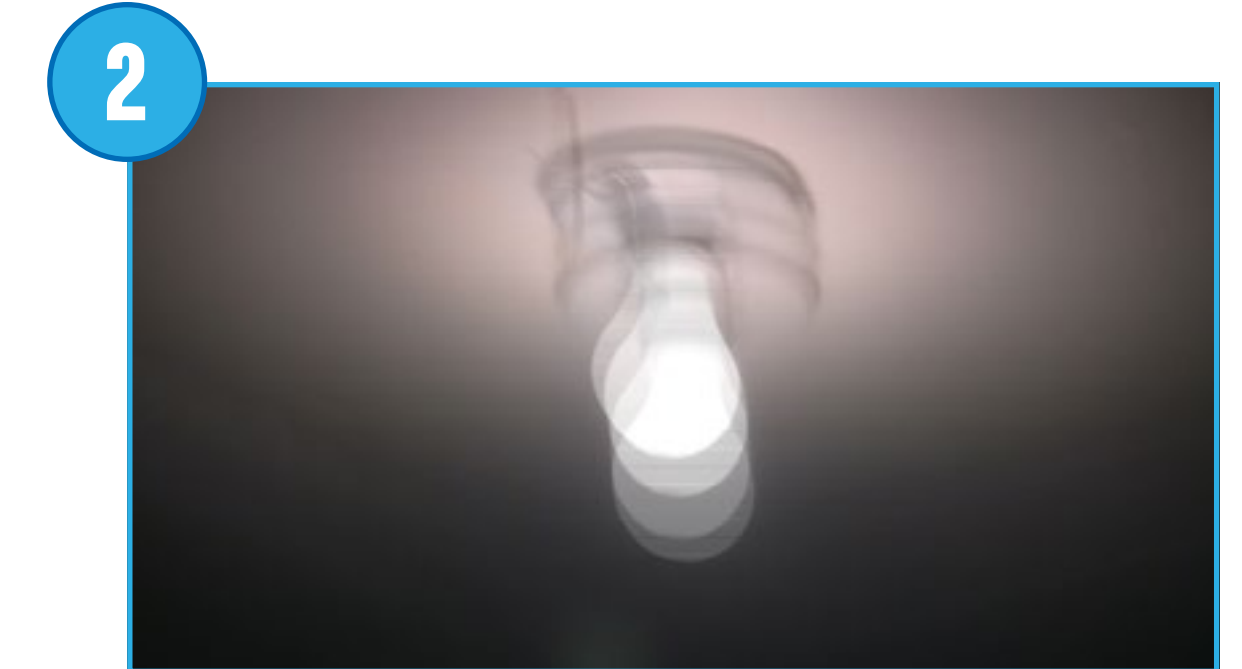



Explore phase

Questions for discussion

During the Explore phase, these questions are intended to elicit students' initial ideas and/or summarize prior learning to evaluate the performance expectation for this project.

Have students document their comprehension, and refer back to these questions again during and after the Create phase.

1. What causes earthquakes and what are the hazards they create?
Earthquakes are vibrations of the earth's crust caused by the movement of the tectonic plate.
2. How do scientists rate the strength of an earthquake?
Scientists rate earthquakes on a scale they call the Richter scale. The higher the number is from no. 1–10, the stronger the vibrations of the earth are.
3. What elements can influence the resistance of buildings during earthquakes?
This answer should serve as the students' hypothesis. This means that at this point, your students' answer may be incorrect.

Have your students collect their answers with text or pictures in the Documentation tool.

Other questions to explore

1. What did you notice about the relationship among the size of a building's footprint, height, and ability to withstand the impact of an earthquake?
Structures that are tall or skinny are generally less stable and are more likely to fall when submitted to lateral forces.
2. How did you ensure that the tests were kept fair each time?
They were changed only one parameter at a time.
3. What other factors would be important to investigate?
Structural designs and various materials are other important factors to consider when testing building resistance.
4. How are modern buildings designed to withstand earthquakes?
Architects and engineers use structures, principles, and simulations to test prototypes for weaknesses.
5. Does "resistant" mean the same thing as "strong"?
It depends on a variety of factors. Sometimes flexible structures or materials are more resistant than stiff and strong ones.



Create phase

Build and program an earthquake simulator and model buildings

Students will follow the building instructions to create an earthquake simulator. With this device, they will gather evidence to decide which building would pass the earthquake test.

1. Build an earthquake simulator.

The shake model used in the project uses a piston to push and pull the test plate. The motor power level of the program determines the amplitude of the earthquake generated.

2. Program the simulator.

This program will start by displaying no. 0 on the screen. It will then repeat a series of actions five times. It will add no. 1 to the display, which will become the shaking magnitude, turn the motor on to that magnitude for 2 sec., and then wait for 1 sec.

▶ Important

With this program, if students want to try a stronger or weaker earthquake, they need to change the number of loops. They should feel free to use a program of their own.





Create phase

Investigate your building design

Now that students understand the way the earthquake simulator works, let them investigate different factors by isolating one variable at a time.

1. Change the height.

Students should use the short and the tall buildings, both with narrow bases (buildings A and B).

With the tall building on the shaking base, students should find the smallest magnitude to which it falls. Then, with that same program, they should test if the narrow or short building can resist better.

Students should be able to discover that with the same base area, the short building can resist better than the tall building.

► Important

Because not all the motors react exactly the same, it is possible that teams have different magnitudes in the investigation.

2. Change the width of the base.

With the same program, have them test if the tall building with the narrow base (building B) can resist better than the narrow, tall building with the wide base (building C).

Students should be able to discover that with a larger base area, a tall building can resist much better.

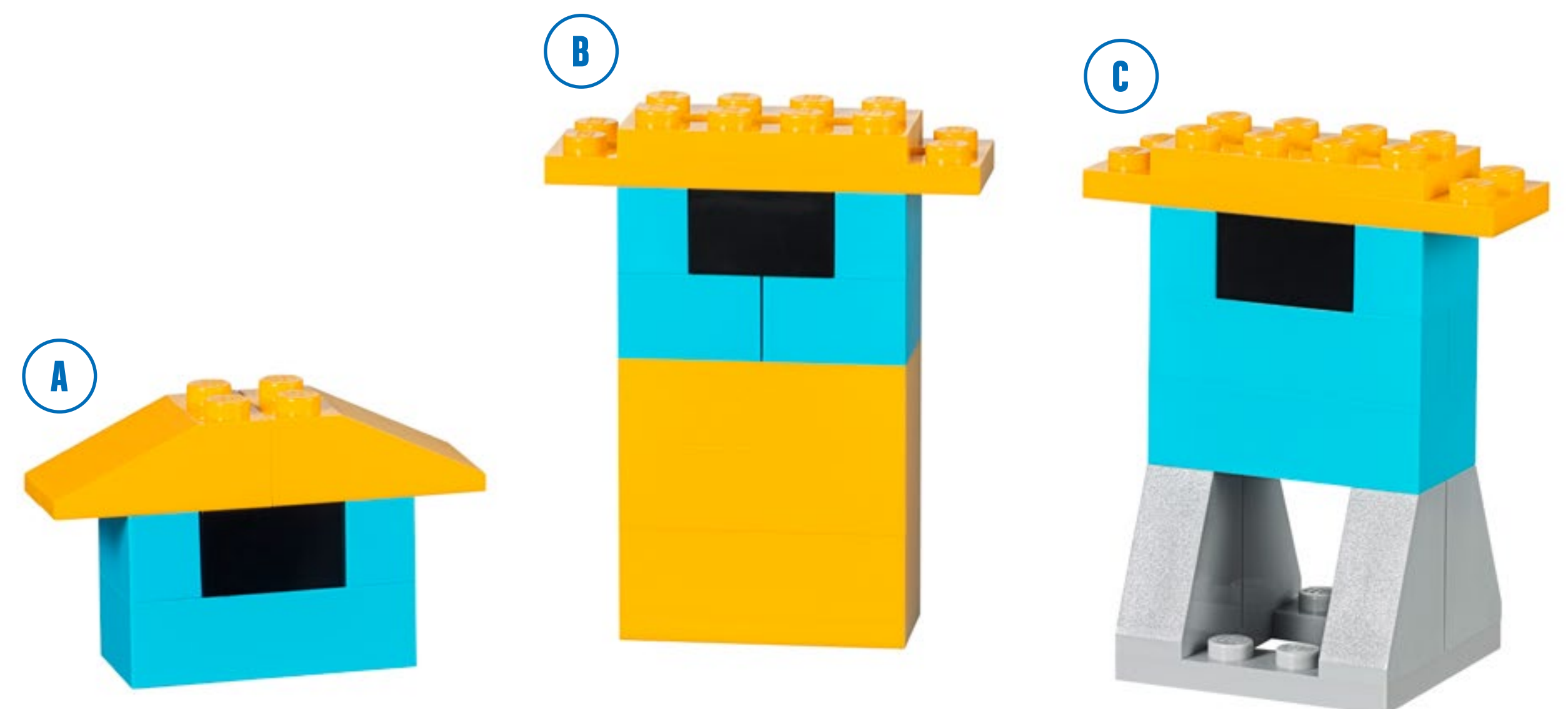



Create phase

Use the “Investigate more” section of the student project as an optional extension. Keep in mind that these tasks extend upon those in the “Investigate” section and are designed for older or more advanced students.

Investigate more with the earthquake simulator

Have your students explore more elements that affect the buildings’ resistance to vibrations.

1. Change the magnitude.

Have your students predict what would happen to building A, B, and C if the magnitude of the earthquake was increased, for example, up to level 8.

Have them record their predictions and test each case.

2. Change buildings.

Applying the fact that a larger base will help a building resist a stronger vibration, challenge your classroom to build the tallest building that could resist a level 8 earthquake.

Have students explore different building compositions:

- Explore different structural shapes.
- Introduce new materials.

Collaboration suggestion

Allow teams to compare their building designs. Have one team describe and test the work of another team:

- What are the strengths of the structure?
- What are the weaknesses of the structure?
- Will the building resist the earthquake test?



Share phase

Complete the document

Have students document their projects in a range of ways:

- Ask students to take a video of each test they conduct in order to prove their claims.
- Ask your students to compare these conclusions with real-life cases.

Suggestions

Students may collect data in a chart format or on a spreadsheet.

Students may also graph the results of their tests.

Present results

At the end of this project, students should present the result of their investigation.

To enhance your students' presentation:

- Ask them to describe which factor influences a building's stability.
- Ask them to compare these thoughts with their findings.
- Ask them to put their explanation in context:
- Ask them to reflect on their conclusions.
- Discuss if their results reflect reality.

Robust Structures

One possible way of sharing

Students in this class are testing the tallest building. They hope it will resist a level 10 earthquake.

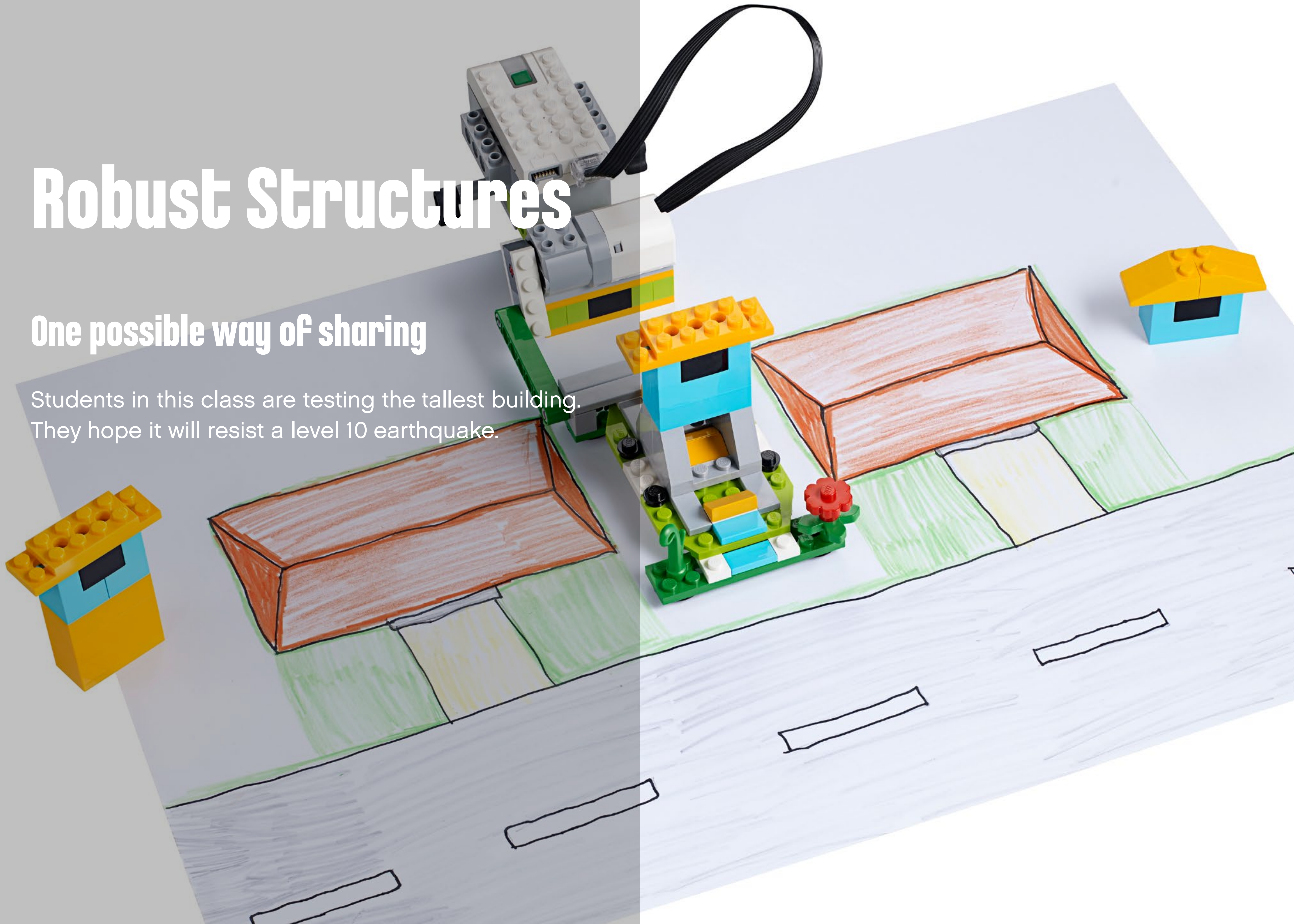

Project 4

Frog's Metamorphosis

This project is about modeling a frog's metamorphosis using a LEGO® representation and identifying the characteristics of the organism at each stage.





Curriculum link

NGSS performance expectation

3-LS1-1: Develop models to describe that organisms have unique and diverse life cycles but all have in common birth, growth, reproduction and death.

3-LS3-1: Analyze and interpret data to provide evidence that plants and animals have traits inherited from parents and that variations of these traits exist in a group of similar organisms.

3-LS3-2: Use evidence to support the explanation that traits can be influenced by the environment.

NGSS crosscutting concepts

Patterns: Cause and effect

Common Core State Standards for English Language Arts

CCSS.ELA-Literacy.SL.2.1: Participate in collaborative conversations with diverse partners about grade 2 topics and texts with peers and adults in small and larger groups.

CCSS.ELA-Literacy.RI.3.3: Describe the relationship among a series of historical events, scientific ideas or concepts, or steps in technical procedures in a text, using language that pertains to time, sequence, and cause/effect.*

*Utilizing supplemental texts about animal life cycles as a component of this project offers the opportunity to address this requirement with students.





Quick glance: Plan this WeDo 2.0 project

Preparation: 30 min.

- Read the general preparation in the “Classroom Management” chapter.
- Read about the project so you have a good idea of what to do.
- Define how you want to introduce this project: Use the video provided in the project in the WeDo 2.0 Software, or use material of your own choice.
- Determine the end result of this project: the parameters to present and produce the document.
- Make sure timing allows for expectations to be met.

► Important

This project uses models to represent a real-world concept. Please refer to the “WeDo 2.0 in Curriculum” chapter for further explanations of modeling practices. It introduces a frog's life as one representation of a life cycle. This project is intended to be an application of students' prior knowledge regarding life cycles of plants and animals. It could be used as an assessment itself.

Explore phase: 30–60 min.

- Start the project using the introductory video.
- Have a group discussion.
- Allow students to document their ideas for Max and Mia's questions using the Documentation tool.

Create phase: 45–60 min.

- Let students build the first model from the provided building instructions.
- Let them program the model with the sample program.
- Allow time so that they can make the young frog evolve into an adult frog. In this step, guide them in building their frog according to what you have discussed in the Explore phase.

Create more phase (optional): 45–60 min.

- If you want, use this extra layer of the project for differentiation or for older students.

Share phase: 45 min. or more

- Make sure your students document the changes in their frogs and explain how they have modified their models to reflect the changes in different stages of a frog's metamorphosis.
- Use different ways to let students share experiences.
- Have your students create their final science report.
- Have students present their projects.

► Suggestion

Have a look at the following Open Projects after this one:

- Predator and Prey
- Extreme Habitats



Differentiation

To ensure success, consider giving more guidance on building and programming, such as:

- How to make back legs longer or how to create front legs
- How to change its appearance by changing its eyes
- Use the Motion Sensor to detect predators and escape.

Also, be specific about how you would like them to present and document their findings, such as with a sharing session among teams, for example.

▶ Suggestion

For more experienced students, you may want to allow them extra time for building and programming to allow them to create models of different animals. Then also ask them to compare and contrast the different animal life cycle models.

You could also revisit the model of the tadpole and determine a way to construct a functional tail. Review the turn base module in the Design Library to get help.

Use the model further

To use the model further, ask your students to study external factors that can influence the life cycle of the frog and its effect on the frog's body. Examples could include: pollution effects, predator elimination, and population changes.

Students' misconceptions

Students might think metamorphosis occurs for all animals. Certain animals have very similar life cycles, and some have very different ones. For example, mammals and insects have very different life cycles, but a horse and a cat are both similar because they are mammals. Explore the following terms while defining a life cycle.

Vocabulary

Life cycle

Important changes in an organism's form that take place in specific stages

Metamorphosis

Extreme physical transformation of an organism, which is usually accompanied by a change of habitat or behavior

Incomplete metamorphosis

An animal that only goes through three stages in the life cycle, for example, a dragonfly

Complete metamorphosis

An animal that completes four stages in the life cycle, for example, the butterfly or frog

Larva

The juvenile form of an animal that goes through metamorphosis (with frogs, a tadpole is in the larval stage)



NGSS project assessment rubrics

You can use these assessment rubrics with the observation rubrics grid, which you will find in the “Assess with WeDo 2.0” chapter.

Explore phase

During the Explore phase, make sure the student is actively involved in the discussion, asks and answers questions, and documents and offers responses to questions, such as, “What are the different stages of a frog’s life?” in his/her own words.

1. The student is not involved in the discussion of the questions posed during the Explore phase, and no documentation is captured.
2. The student contributes little to the discussion of the questions posed during the Explore phase and documents some of his/her responses.
3. The student contributes sufficiently to the discussion of the questions posed during the Explore phase and adequately documents his/her responses.
4. The student actively contributes to the discussion of the questions posed during the Explore phase and documents his/her responses.

Create phase

During the Create phase, make sure the student actively investigates solutions by planning, designing, and redesigning, if necessary, and can apply his/her understanding of the life cycle of a frog to represent it in a model.

1. The student neglects to create a model to represent the frog life cycle that demonstrates evidence of comprehension.
2. The student creates a model to represent the frog life cycle that demonstrates some evidence of comprehension.
3. The student successfully creates a model to represent the frog life cycle that demonstrates adequate evidence of comprehension.
4. The student creates a model to represent the frog life cycle that demonstrates evidence of a highly developed comprehension.

Share phase

During the Share phase, make sure the student can explain the life cycle of the frog and the changes it undergoes; identify limitations of their model (what is close to reality and what is not); and use important information from his/her project to create the final report.

1. The student neglects to discuss the limitations of the model or the life cycle of a frog. The student does not use the information to create the final report.
2. The student is able to discuss, with prompting, some of the limitations of the model and the life cycle of a frog. The student uses some information to create the final report.
3. The student is able to adequately discuss the limitations of the model and the life cycle of a frog and use all necessary information to create the final report.
4. The student discusses the limitations of the model and the life cycle of a frog and uses all necessary information to create the final report.



ELA project assessment rubrics

You can use these assessment rubrics with the observation rubrics grid, which you will find in the “Assess with WeDo 2.0” chapter.

Explore phase

During the Explore phase, make sure the student can effectively explain his/her own ideas through collaboration with peers.

1. The student does not share his/her ideas related to the questions posed during the Explore phase and show evidence of collaboration with peers.
2. The student is able, with prompting, to share his/her ideas through collaboration with peers during the Explore phase.
3. The student adequately shares his/her ideas through collaboration with peers during the Explore phase.
4. The student uses details to share insightful ideas through collaboration with peers during the Explore phase.

Create phase

During the Create phase, make sure the student uses precise language and appropriate vocabulary and makes appropriate choices in communicating concepts using the Documentation tool.

1. The student does not use precise language or vocabulary appropriately and demonstrate thoughtful choices in communicating concepts with the Documentation tool.
2. With prompting, the student can incorporate some appropriate vocabulary and generally makes appropriate choices in communicating concepts using the Documentation tool.
3. The student uses precise language and appropriate vocabulary and makes appropriate choices in communicating concepts using the Documentation tool.
4. The student uses precise language and advanced vocabulary and makes appropriate choices in communicating concepts using the Documentation tool.

Share phase

During the Share phase, make sure the student describes the relationship among the model and scientific concepts related to the life cycle of a frog using appropriate vocabulary.

1. The student does not effectively describe the relationship among the model and any scientific concepts related to the life cycle of a frog.
2. The student describes the relationship among the model and scientific concepts related to the life cycle of a frog, but there are inaccuracies and relevant pieces of information are missing.
3. The student adequately describes the relationship among the model and scientific concepts related to the life cycle of a frog using appropriate vocabulary.
4. The student describes, in detail, the relationship among the model and scientific concepts related to the life cycle of a frog using advanced vocabulary.



Explore phase

The introductory video may set the stage for the following ideas to be reviewed and discussed with students for this project.

Introductory video

Unlike mammals, frogs go through metamorphosis during their lives:

1. Frogs start their lives as eggs. Not all baby frogs will survive as many will be eaten by predators.
2. When the eggs hatch, the tadpoles start looking for food sources.
3. Tadpoles slowly grow legs as they become young frogs (froglets).
4. For many species, after about twelve weeks, the frog has its adult shape and is ready to jump, eat flies, and reproduce.

Although this varies among frog species, the metamorphosis of a typical frog from birth to adult takes an average of sixteen weeks. Once a frog has reached adulthood, it can reproduce. There are species of frog that have a life span of less than two years, while other species may live up to fifteen or more years.

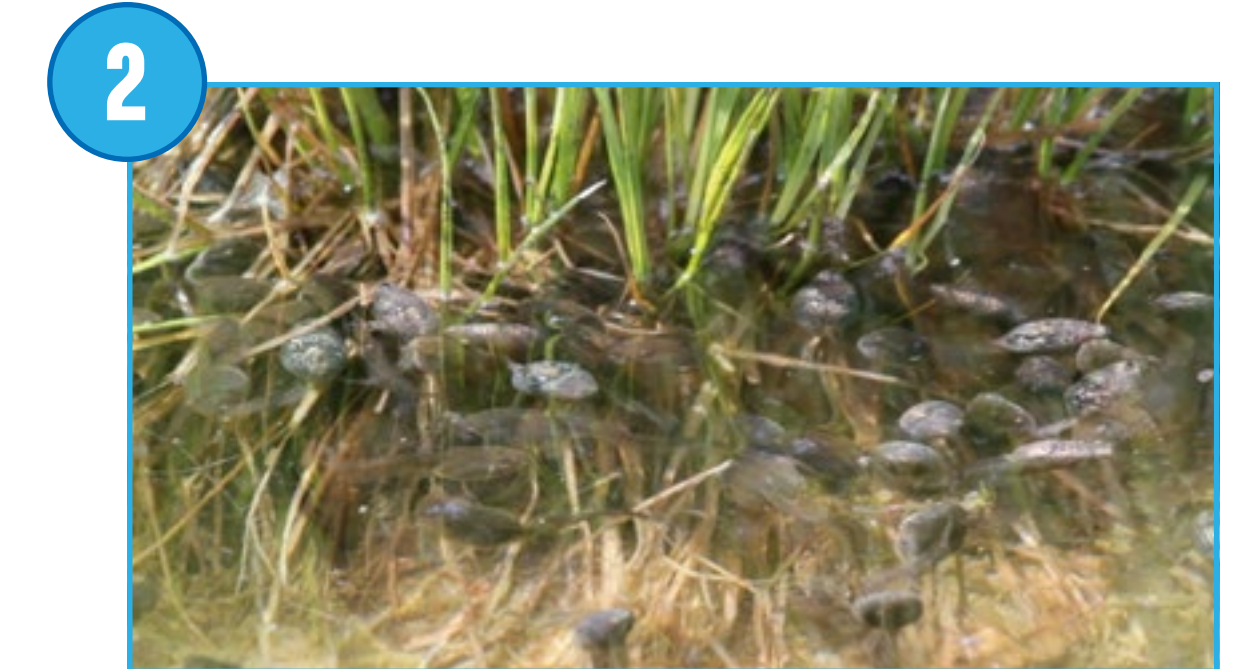



Explore phase

Questions for discussion

1. What physical features are changing as a frog progresses from tadpole to adult?
The jaw changes shape, tail recedes, tongue for catching flies develops, hind legs and then front legs begin to grow, and lungs develop as gills disappear. This is merely a list of some of the most obvious changes that occur as a frog undergoes metamorphosis and is not intended to be an exhaustive description.
2. What are some links among the changes of a frog's physical characteristics and its habitat?
Animals morph so they can survive in a new environment. Tadpoles often move from aquatic to terrestrial environments as they morph into adult frogs, so their bodies must support different ways of eating, breathing, and moving.

Your students can collect their answers in the Documentation tool.

Other questions to explore

1. How are life cycles of plants and animals similar?
Plants have similar life cycles to frogs because they both change shape during their lives and have a stage where they don't look like the adult stage (tadpole in the case of the frog, seedling in the case of the plant).
2. What are the stages in the life of a frog?
For frogs, it would be egg-->tadpole-->froglet (young frog)-->adult frog.
For other animals, answers will vary.
3. Are frogs the only animal to go through metamorphoses during their life cycle?
No, butterflies and moths undergo complete metamorphoses, and dragonflies and many fish experience incomplete metamorphoses (as well as various other organisms).
4. Do humans go through metamorphoses? How do you know?
Although humans' body shapes grow during their lives, they don't change.



Create phase

1. Build a model of a tadpole (larva).

Students will start to build a tadpole with only eyes, a long tail, and, at first, no front legs. Have them take a picture of this stage or sketch it in order to document it before they morph it into the young frog.

2. Build a young frog model (froglet).

Students will follow the building instructions to morph the tadpole into a young frog that can move if activated by a program. Let the students describe the changes they note as the model progresses.

One important, new feature that has changed in the young frog is the development of back legs. The walk module used in the project uses gears. These gears move the back legs.

Students should once again document their models using pictures and/or sketches.

3. Program the young frog.

This program will turn the motor on in one direction at motor power 8 for 3 sec. and then stop it.

▶ Suggestion

Before your students start to modify their model, have them change the parameters of the program so they fully understand it.





Create phase

Morphing from a young frog (froglet) to an adult frog

After building the young frog, students should then modify it to create their own model.

There will be many possible solutions. Here are some examples:

1. Change both front and back legs.

The young frog will develop both front and back legs during its life. Students could build bigger legs in the back and create front legs. Students can also change the positions of the legs to show the different types of movements made by an adult frog. Students may modify their existing programs or create new ones to move the new legs.

2. Other changes in appearance

Removing the tail, adding a mature tongue, changing the eye position, and adding patterns on the skin are additional ways to make the model look like an adult frog.

3. Replicate adult frog behavior.

Students could use sounds or the Motion Sensor to change the frog's behavior. For example, with a Motion Sensor placed on the frog's head, it could be programmed to wait until it detects an object such as a hand and then move backward.

► Important

It is important to note that because a student model will vary according to student choice, there are no building instructions or sample programs provided to students for this part of the project.





Create phase

The “Use the model further” section of the student project is an optional extension. Keep in mind that these tasks extend upon those of the “Use the model” section and are designed for older or more advanced students.

Use the model further

Frogs are amphibians that are very sensitive to the environment. For example, they have a porous skin that can allow chemicals to affect their development.

Ask students to research the effects of damaging external factors on the frog life cycle. For example:

- Changes (such as damage or destruction) of habitats: Frogs would not find a mate or would not be able to move freely or find food that they need.
- Pollution or disease: Frogs could mutate by growing an extra leg or losing one.

Have your students illustrate with their model the effect of such factors on frog behavior and on the frog's life cycle.

Suggestion

The framework for science education stresses that plants and animals have predictable characteristics relating to life processes, change, and growth. Animals and plants have similar growth processes, and offspring are related to the previous generations as inherent traits are realized. You could expand this modeling project to include other plants and animals.

Collaboration suggestion

Have teams compare and share their findings and have them share the impact of external factors on the frog populations.



Share phase

Complete the document

Have students document their project in a variety of ways:

- Ask students to take a picture of every stage they create and prepare to discuss how the model represents a frog's metamorphosis.
- Ask your students to compare images of their models with real-life images.
- Ask your students to record a video of them describing their project.

Present results

At the end of this project, students should present what they learned.

To enhance your students' presentation:

- Have students explain the life cycle of the frog.
- Make sure they can explain the different stages.
- Have them compare this life cycle with other animals.
- Have them describe the limitations of their model.
- Ask them to create a display to put the frog's metamorphosis into context.

Frog's Metamorphosis

One possible way of sharing

Students in this class explain that morphing into an adult frog allows them to move from water to a land environment.



Project 5

Plants and Pollinators

This project is about modeling a LEGO® representation of the relationship between a pollinator and flower during the reproduction phase.





Curriculum link

NGSS performance expectation

2-LS2-2: Develop a simple model that mimics the function of an animal in dispersing seeds or pollinating plants.

4-LS1-1: Construct an argument that plants and animals have internal and external structures that function to support survival, growth, behavior, and reproduction.

NGSS crosscutting concepts

Systems and systems models and structure and function.

Common Core State Standards for English Language Arts

CCSS.ELA-Literacy.W.2.6: With guidance and support from adults, use a variety of digital tools to produce and publish writing, including in collaboration with peers.

CCSS.ELA-Literacy.W.4.1.b: Provide reasons that are supported by facts and details.

CCSS.ELA-Literacy.W.4.2.d: Use precise language and domain-specific vocabulary to inform about or explain the topic.





Quick glance: Plan this WeDo 2.0 project

Preparation: 30 min.

- Read the general preparation in the “Classroom Management” chapter.
- Read about the project so you have a good idea of what to do.
- Define how you want to introduce this project: Use the video provided in the project in the WeDo 2.0 Software, or use material of your own choice.
- Determine the end result of this project: the parameters to present and produce the document.
- Make sure timing allows for expectations to be met.

► Important

This project uses models to represent a real-world concept. Please refer to the “WeDo 2.0 in Curriculum” chapter for further explanations of modeling practices.

Explore phase: 30–60 min.

- Start the project using the introductory video.
- Have a group discussion.
- Allow students to document their ideas for Max and Mia’s questions using the Documentation tool.

Create phase: 45–60 min.

- Let students build the first model from the provided building instructions.
- Let them program the model with the sample program.
- Allow time so they can make different types of flowers as well as corresponding pollinators. Make sure students can explain the links between the two organisms.

Create more phase (optional): 45–60 min.

- If you want, use this extra layer of the project for differentiation or for older students.

Share phase: 45 min. or more

- Make sure your students document their work when they build new flowers and pollinators.
- Use different ways to let students share what they have learned and their reflections on these experiences.
- Have students create their final reports and present the projects.

► Suggestion

Have a look at the following Open Projects after this one:

- Animal Expression
- Wildlife Crossing



Differentiation

To ensure success, consider giving more guidance on building and programming, such as:

- Provide a list and images of potential pollinators.
- Provide a list of flower characteristics.

Be flexible on how flowers are built and focus on what is most important: the general shape of the flower and its color.

Also, be specific about how you would like them to present and document their findings, such as with a sharing session among teams, for example.

▶ Suggestion

For more experienced students, you may want to allow them extra time for building and programming so they can model flowers that best replicate reality, using stamen, stigma, petals and other parts.

Use the model further

To use the model further, ask your students to explore the phases of the life cycle after the plant has been pollinated, such as seed dispersion.

Students' misconceptions

Students may believe that the main purpose of a pollinator is actually to be deliberately responsible for the reproduction of a plant. It is more by chance that this phenomenon happens. The pollinator visits the flower with the intention of obtaining nutrients, and it is only indirectly that it transfers the pollen.

Vocabulary

Pollen

Powdery particles required for plant reproduction

Nectar

Liquid filled with sugar produced by plants to attract animals

Seed

A plant embryo provided in a protective shell

Stamen

Pollen-producing reproductive organ of a flower

Stigma

Pollen receptor organ of a flower

Pollinator

A living creature involved in the transport of pollen

Cross-pollination

Fertilization of one plant by another



NGSS project assessment rubrics

You can use these assessment rubrics with the observation rubrics grid, which you will find in the “Assess with WeDo 2.0” chapter.

Explore phase

During the Explore phase, make sure the student is actively involved in the discussion, asking and answering questions, and can answer in his/her own words questions such as: What makes a pollinator choose the right flower?

1. The student is unable to provide answers to questions or participate in discussions adequately or neglects to answer the questions posed during the Explore phase.
2. The student is able, with prompting, to provide answers to questions or participate in discussions adequately or, with prompting, answers some or all of the questions posed during the Explore phase.
3. The student is able to provide adequate answers to questions and participate in class discussions and answer the questions posed during the Explore phase in his/her own words.
4. The student is able to extend the explanations in discussions and answer the questions posed during the Explore phase in his/her own words.

Create phase

During the Create phase, make sure the student has developed a model that successfully demonstrates the function in an animal to disperse seeds or pollinate plants.

1. The student provides little or no evidence of an attempt to develop a model that demonstrates the function of an animal to disperse seeds or pollinate plants.
2. The student has attempted to develop a model that demonstrates the function of an animal to disperse seeds or pollinate plants, but some components of the model are incomplete or incorrect.

3. The student has developed a model that successfully demonstrates the function of an animal to disperse seeds or pollinate plants.
4. The student has developed an exceptional model that successfully demonstrates the function of an animal to disperse seeds or pollinate plants.

Share phase

During the Share phase, make sure the student can explain what is happening in the pollination phase of a flower and identify the limitations of the model—what is close to reality and what might be unrealistic.

1. The student provides little to no accurate explanation of what is happening in the pollination phase and is unable to identify the limitations of the model.
2. With prompting, the student can explain with accuracy what is happening in the pollination phase and may or may not identify the limitations of the model.
3. The student can explain with accuracy what is happening in the pollination phase and identify specific limitations of the model.
4. With ease and accuracy, the student can explain what is happening in the pollination phase and is able to clearly identify specific limitations of the model.



ELA project assessment rubrics

You can use these assessment rubrics with the observation rubrics grid, which you will find in the “Assess with WeDo 2.0” chapter.

Explore phase

During the Explore phase, make sure the student can effectively explain his/her own ideas and comprehension related to the questions posed.

1. The student is unable to share his/her ideas related to the questions posed during the Explore phase.
2. The student is able, with prompting, to share his/her ideas related to the questions posed during the Explore phase.
3. The student adequately expresses his/her ideas related to the questions posed during the Explore phase.
4. The student uses details to extend explanations of his/her ideas related to the questions posed during the Explore phase.

Create phase

During the Create phase, make sure the student uses precise language and appropriate vocabulary and makes appropriate choices in communicating concepts using the Documentation tool.

1. The student does not use precise language or vocabulary appropriately and demonstrate thoughtful choices in communicating concepts with the Documentation tool.
2. With prompting, the student can incorporate some appropriate vocabulary and generally makes appropriate choices in communicating concepts using the Documentation tool.
3. The student uses precise language and appropriate vocabulary and makes appropriate choices in communicating concepts using the Documentation tool.
4. The student uses precise language and advanced vocabulary and makes appropriate choices in communicating concepts using the Documentation tool.

Share phase

During the Share phase, make sure the student provides reasons that are supported by scientific facts about pollination to discuss how his/her model demonstrates how animals contribute to the life cycle of plants.

1. The student provides no reasons with supporting facts about pollination to discuss how his/her model demonstrates how animals contribute to the life cycle of plants.
2. The student provides one reason that is supported by scientific facts about pollination to discuss how his/her model demonstrates how animals contribute to the life cycle of plants.
3. The student provides more than one reason supported by scientific facts about pollination to discuss how his/her model demonstrates how animals contribute to the life cycle of plants.
4. The student provides several reasons that are well supported by scientific facts about pollination to discuss how his/her model demonstrates how animals contribute to the life cycle of plants.



Explore phase

The introductory video may set the stage for the following ideas to be reviewed and discussed with students for this project.

Introductory video

Pollination is a vital process by which a flower is affected by an external factor in order to have the pollen transported to the stigma:

1. Flowers rely on external factors, such as wind or animals, to help them reproduce.
2. The flower of a plant is designed to attract animals. The color, the size, the smell, and the nectar are all tricks to attract them.
3. Butterflies and moths have long tongues so they like tubular flowers and are attracted by bright red flowers.
4. Hummingbirds have long beaks, perfect for reaching nectar deep inside of tubular flowers.
5. Bats also play a role in pollination, using their very long tongues to get the nectar from flowers, mainly at night.

Pollination is only one step in a flowering plant's life cycle. After the flower has been pollinated, the fruit or the seed will develop on the plant. The plant then gets further assistance from animals or an external force, such as the wind or rain, to disperse the seeds.

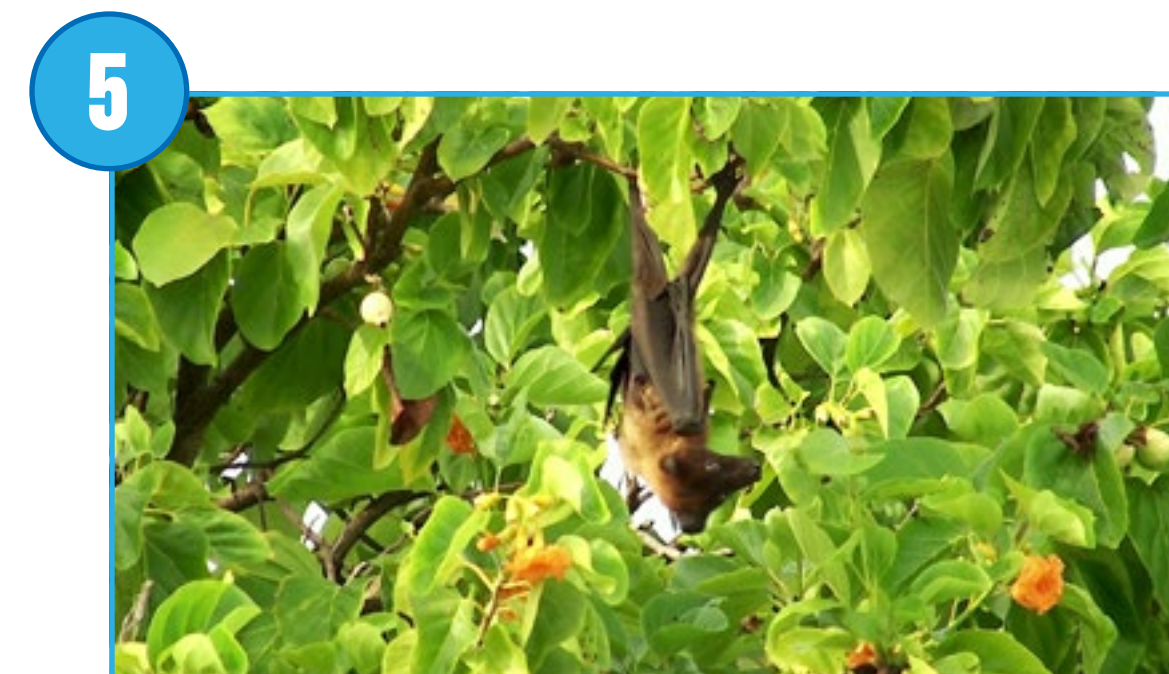
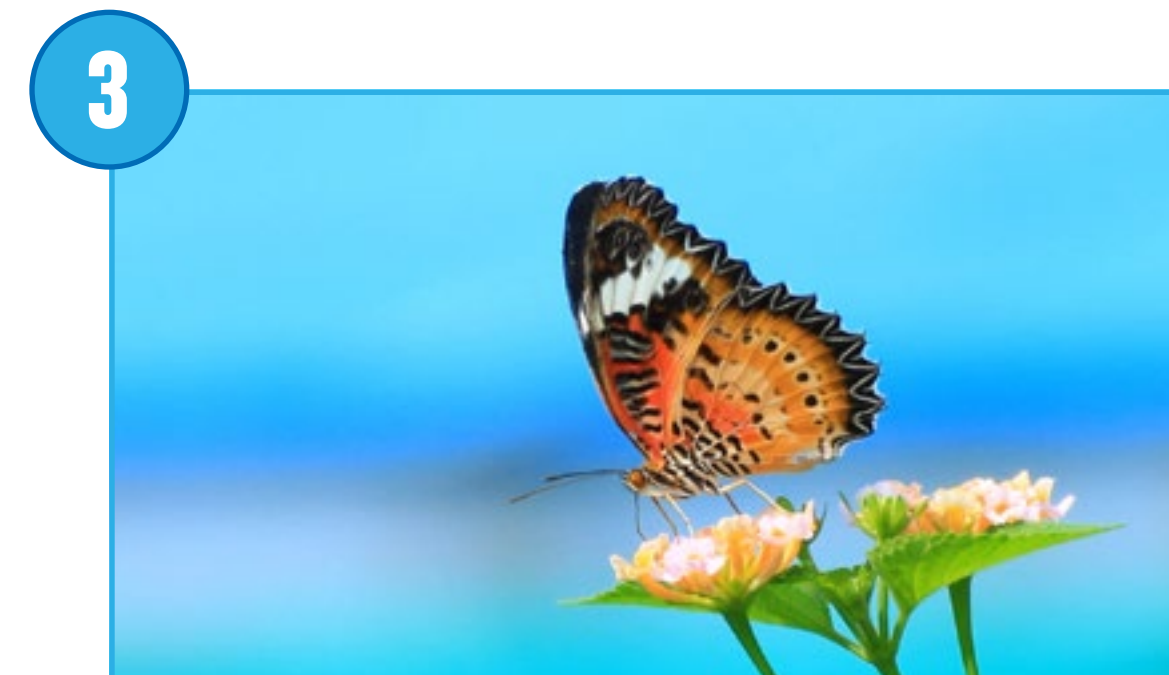
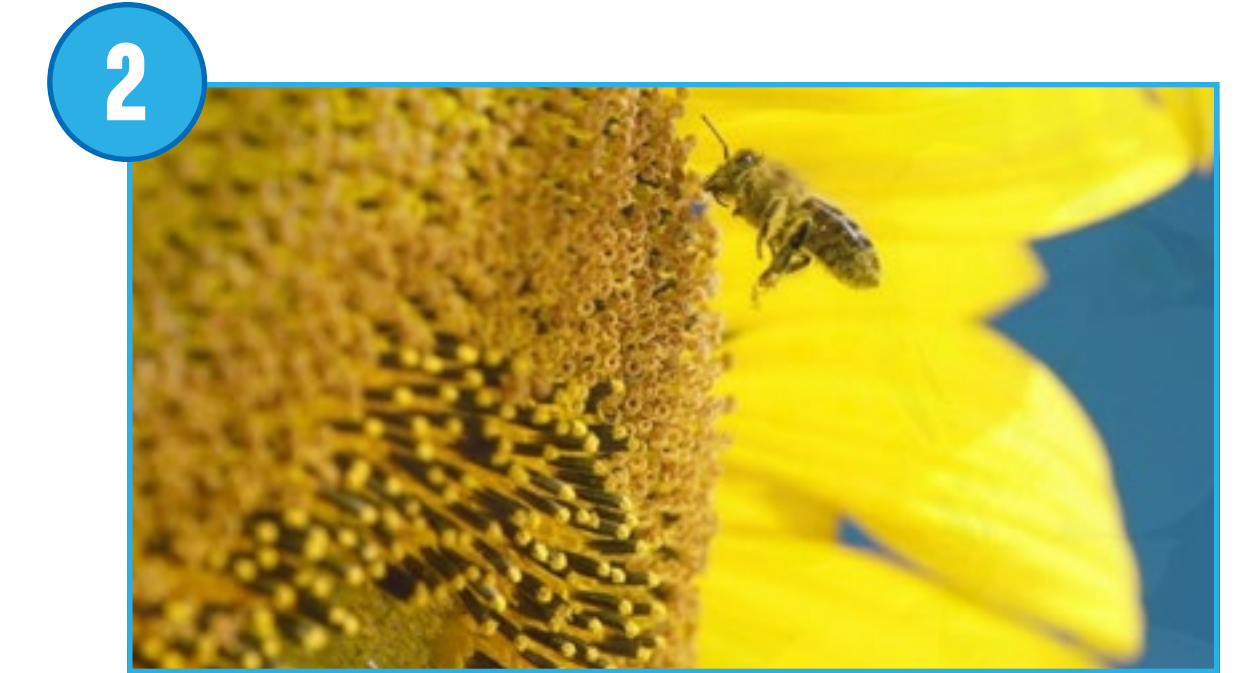



Explore phase

Questions for discussion

1. What are the parts of a flower?

Anther, stamen, stigma, style, pollen, nectar

2. Explain some ways that animals help plants to reproduce.

Pollinating animals go to the flower for nectar and often will get dusted with nearby pollen to be transferred from (usually) one flower to the next. Most flowering plants rely on animals to pollinate them, and animals also help to disperse seeds of many plants.

3. What are these processes called?

Pollination is the process by which flowers reproduce. Around 90 percent of all pollination on the planet involves organisms. This is biotic pollination.

Have your students collect their answers with text or pictures in the Documentation tool.

Other questions to explore

1. Name three stages in the life of a flowering plant.

Seed, seedling (tiny plant), and mature plant with flower

2. What is the role of a flower?

The flower is the organ developed by a plant to attract animals in order to get help in the reproductive process and create seeds.

3. Do all flowers get pollinated by a pollinator?

Some pollination takes place using the wind or rain.



Create phase

Build and program a pollination model

Students will use the building instructions to create a model of a bee and generic flower.

1. Build a pollination scenario.

This project model uses gears. These gears move on an axle to which the bee is attached. The flower uses a Motion Sensor to detect when the bee is on top of it.

2. Program the bee and the flower.

This program will turn the motor on in one direction until the bee is detected on top of the flower. When this happens, the motor will stop and the bee sound will be played.

Have students use the transparent brick to represent pollen.

▶ Suggestion

Before your students start to modify their model, have them change the parameters of the program so they fully understand it.





Create phase

Describe a pollination scenario

Using ideas from the first model, the student should be able to change both the pollinator and flower.

Once students have built the bee, ask them to think about how they might build a new flower and a pollinator that would be attracted to it.

Encourage students to plan and test their designs.

1. Build a new flower.

As some examples, students may build a tubular, colored, or big flower.

When they design this flower, make sure they:

- Keep the Motion Sensor in the new flower.
- Use the transparent brick to represent pollen.
- Also design the correct pollinator for it.

2. Build a new pollinator.

As an example, students can build a hummingbird, butterfly, bug, bat, or any other organism they know is a pollinator. When they design this pollinator, make sure they can:

- Attach their new pollinators to the axle.
- Design the correct flower for it.

3. Program a new scenario.

As an example, students can use a second flower to illustrate cross-pollination.

To do that, make sure they:

- Program the new pollinator model to act differently from the previous one.

▶ Important

It is important to note that because a student model will vary according to student choice, there are no building instructions or sample programs provided to students for this part of the project.

Collaboration suggestion

If teams work together, students can ask each other if the pollinator of one can pollinate the flower of the other and vice versa.



Create phase

The “Use the model further” section of the student project is an optional extension. Keep in mind that these tasks extend upon those of the “Use the model” section and are designed for older or more advanced students.

Use the model further

After the flower is pollinated, seeds or fruit appear on the plant.

1. Build and program a seed dispersion scenario.

Ask students to modify the plant after the flower has been pollinated. Have students explore the different types of seed dispersal. Have them pick one and create a model to represent it.

For example:

- Seeds hidden inside of an attractive fruit to be eaten by an animal
- Seeds carried by other animals and birds
- Seeds transported by wind or water
- Seeds that have self-propulsion mechanisms



Share phase

Complete the document

Have students include in their final products a picture of every stage of the pollination process:

- Ask your students to compare these images with real-life images.
- Ask your students to record a video of themselves describing how animals help plants to reproduce.

Present results

At the end of this project, students should present what they learned.

To enhance your students' presentations:

- Have students use the model to explain the relationship between the pollinator and the flower in the context of a plant life cycle.
- Make sure they can explain why and how the pollinator plays an active role in the pollination process.
- Ask them to put some context into their explanation, such as describing where the flower is, in what season it is happening, etc.

Plants and Pollinators

One possible way of sharing

Students in this class use their models to explain how the bee can pollinate the flower.



Project 6

Prevent Flooding

This project is about designing an automatic LEGO® floodgate to control water according to various precipitation patterns.

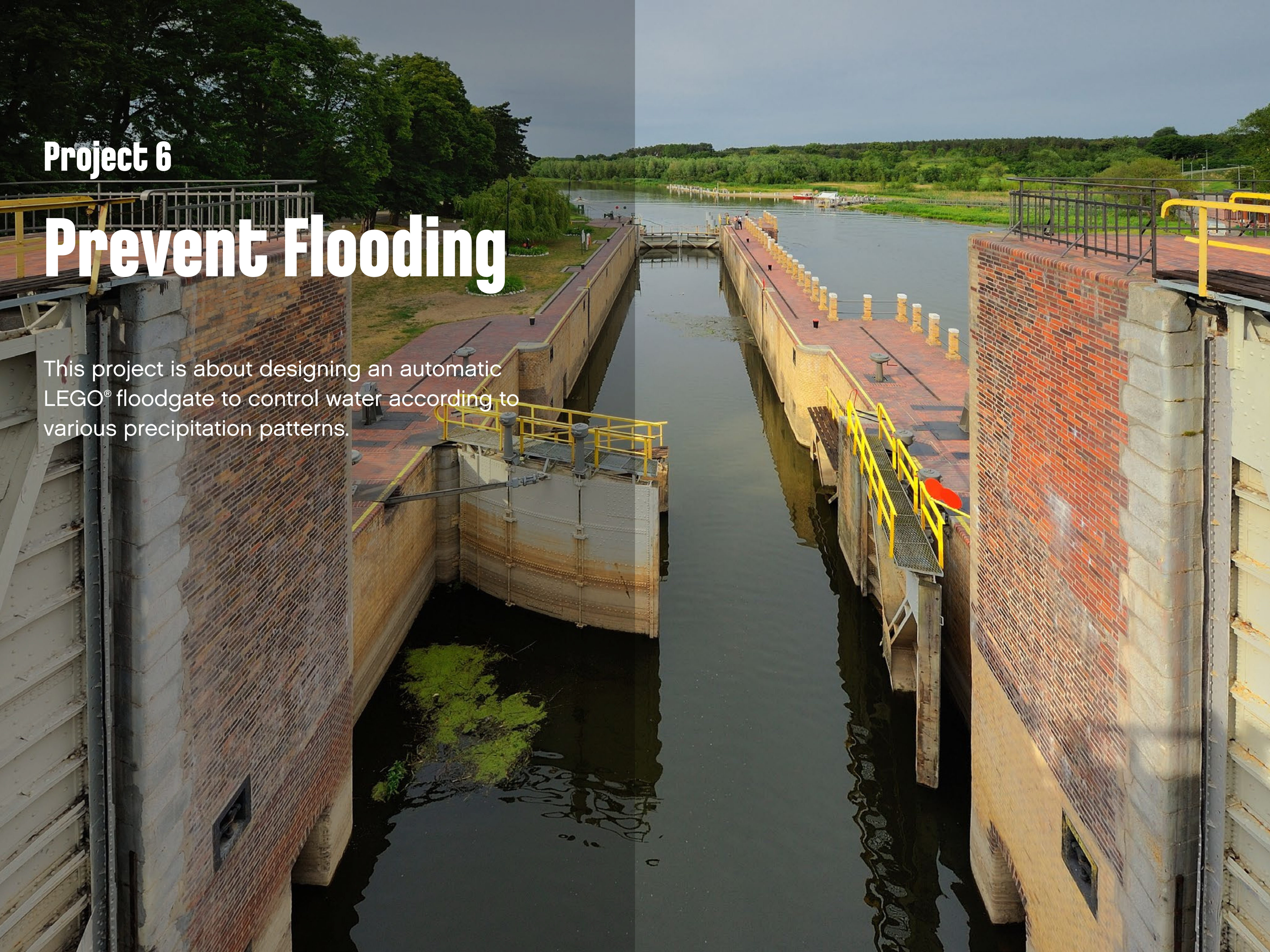



Curriculum link

NGSS performance expectation

2-ESS2-1: Compare multiple solutions designed to slow or prevent wind or water from changing the shape of the land.

3-ESS2-1: Represent data in tables and graphical displays to describe typical weather conditions expected during a season.

3-ESS3-1: Make a claim about the merit of a design solution that reduces the impacts of a weather-related hazard.

4-ESS2-2: Analyze and interpret data from maps to describe patterns of earth's features.

NGSS crosscutting concepts

Patterns, stability and change

Common Core State Standards for English Language Arts

CCSS.ELA-Literacy.W.2.7: Participate in shared research and writing projects (e.g., read a number of books on a single topic to produce a report; record science observations).

CCSS.ELA-Literacy.SL.3.1.a: Come to discussions prepared, having read or studied required material; explicitly draw on that preparation and other information known about the topic to explore ideas under discussion.

CCSS.ELA-Literacy.RL3.7: Use information gained from illustrations, (e.g., maps, photographs) and the words in a text to demonstrate comprehension of the text.

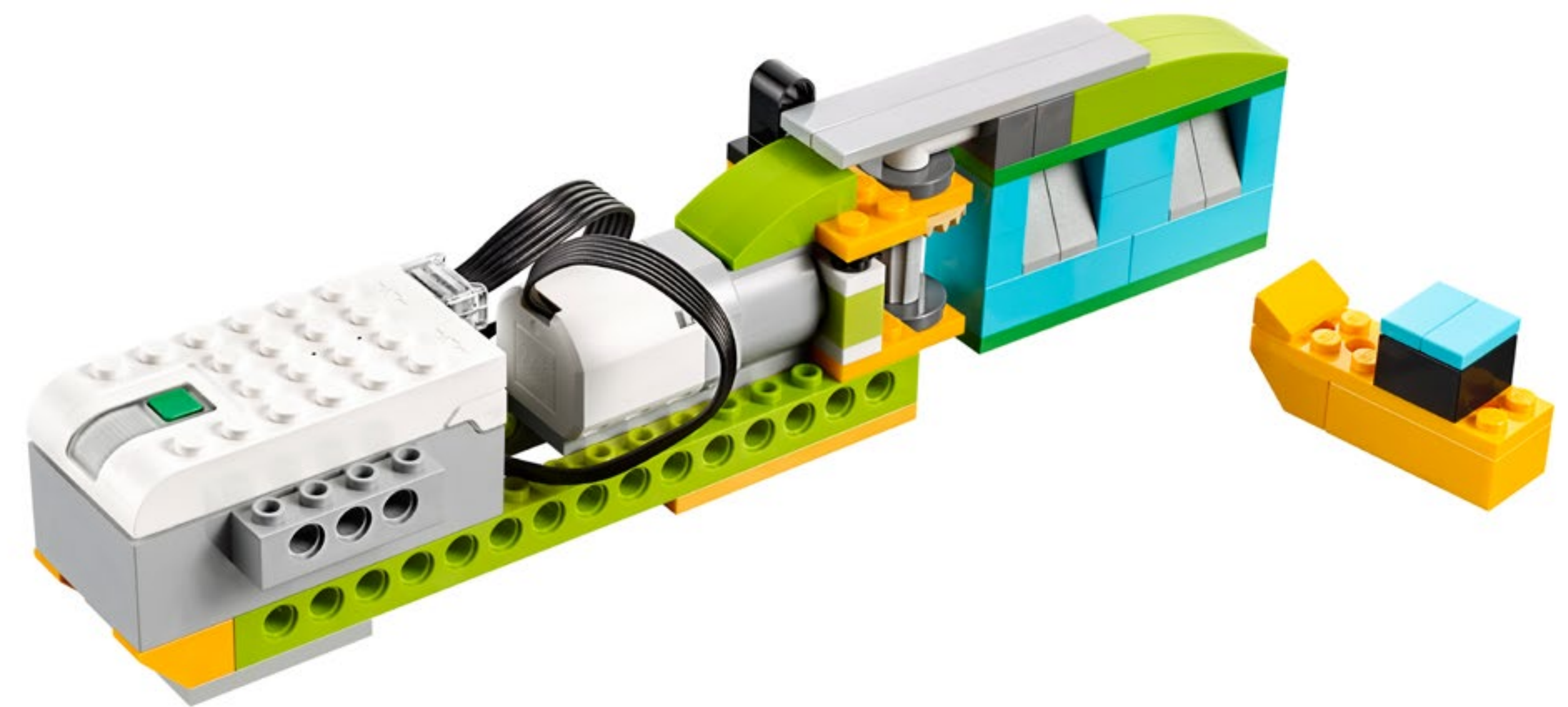



Quick glance: Plan this WeDo 2.0 project

Preparation: 30 min.

- Read the general preparation in the “Classroom Management” chapter.
- Read about the project so you have a good idea of what to do.
- Define how you want to introduce this project: Use the video provided in the project in the WeDo 2.0 Software, or use material of your own choice.
- Determine the end result of this project: the parameters to present and produce the document.
- Make sure timing allows for expectations to be met.

▶ Important

This project is a design brief. Please refer to the “WeDo 2.0 in Curriculum” chapter for further explanations of design practices.

Explore phase: 30–60 min.

- Start the project using the introductory video.
- Have a group discussion.
- Allow students to document their ideas for Max and Mia’s questions using the Documentation tool.

Create phase: 45–60 min.

- Let students build the first model from the provided building instructions.
- Let them program the model with the sample program.
- Allow time for them to build different devices to create automatic doors.

Create more phase (optional): 45–60 min.

- If you want, use this extra layer of the project for differentiation or for older students.

Share phase: 45 min. or more

- Make sure your students document their work when they are using sensors.
- Let your students share experiences in different ways.
- Have your students create their final science report and present their projects.

▶ Suggestion

Have a look at the following Open Projects after this one:

- [Hazard Alarm](#)
- [Extreme Habitats](#)



Differentiation

To ensure success, consider giving more guidance on building and programming, such as:

- Explain how to use sensors.
- Define the types of precipitation in each season with your students and help them determine which one to focus on.
- Explain engineering-based design.

Also, be specific about how you would like them to present and document their findings, such as with a sharing session among teams, for example.

Suggestion

For more experienced students, you may want to allow them extra time for building and programming to allow them to create different and more extensive types of devices. Ask them to use the design process to explain all the versions they made.

Design further solutions

To design further solutions, ask the students to use their knowledge of the floodgate and different water sources to describe the stream of water they are trying to control and the position of mountains, cities, and lakes. Provide them with opportunities to expand the design process to include other ideas about how floodgates function or other automatic types of doors.

Students' misconceptions

Students tend to view the earth as static, stable, and unchanging. They often have difficulty believing that rocks can change or be worn down through the process of weathering. They often have difficulty understanding the role of a dam or floodgate in the protection of land masses.

Vocabulary

Floodgate

An adjustable gate used to control the flow of water

Sluice

Artificial water channel controlled at its head by a gate

Dike

Wall that holds water back

Upstream

Moving toward the water's source

Downstream

Water that travels from the original source

Precipitation

Any form of water, such as rain, snow, sleet, or hail, that falls to the earth's surface

Dam

A barrier that impounds water or underground streams

Erosion

The act in which earth is worn away, often by water, wind, or ice

Automate

To work on its own, operated by a machine or computer, instead of by a human



NGSS project assessment rubrics

You can use these assessment rubrics with the observation rubrics grid, which you will find in the “Assess with WeDo 2.0” chapter.

Explore phase

During the Explore phase, make sure the student is actively involved in the discussion, asking and answering questions, and can create a graph of precipitation for each season.

1. The student is unable to provide answers to questions or participate in discussions adequately or create a graph of precipitation for each season.
2. The student is able, with prompting, to provide answers to questions or participate in discussions adequately or with help and create a graph of precipitation for each season.
3. The student is able to provide adequate answers to questions and participate in class discussion and create a graph of precipitation for each season.
4. The student is able to extend the explanations in discussion and create a graph of precipitation for each season.

Create phase

During the Create phase, make sure the student works well on a team, justifies his/her best solution, and uses the information collected in the Explore phase.

1. The student is unable to work well on a team, justify solutions, and use information collected for further development.
2. The student is able to work on a team, collect and use information with guidance, or, with help, to justify solutions.
3. The student is able to work on a team and contribute to the team discussions, justify solutions, and collect and use information about the content.
4. The student is able to work on a team and serve as the leader and justify and discuss solutions that allow for the collection and use of information.

Share phase

During the Share phase, make sure the student can explain how the new design for the floodgate was created, has used sensors to control the floodgate, and can use important information from the project to create a final report.

1. The student is unable to engage in the discussions about the design or explain the model using sensors and use the information to create a final project.
2. The student is able, with prompting, to engage in the discussions about the design of the floodgate and the use of sensors and use limited information to create a final project.
3. The student is able to engage in discussions about the design of the floodgate and the use of sensors and use the information gathered to produce a final project.
4. The student is able to engage extensively in class discussions about the topic and use information gathered to create a final project that includes additional required elements.



ELA project assessment rubrics

You can use these assessment rubrics with the observation rubrics grid, which you will find in the “Assess with WeDo 2.0” chapter.

Explore phase

During the Explore phase, make sure the student can effectively explain his/her own ideas and comprehension related to the questions posed.

1. The student is unable to share his/her ideas related to the questions posed during the Explore phase.
2. The student is able, with prompting, to share his/her ideas related to the questions posed during the Explore phase.
3. The student adequately expresses his/her ideas related to the questions posed during the Explore phase.
4. The student uses details to extend explanations of his/her ideas related to the questions posed during the Explore phase.

Create phase

During the Create phase, make sure the student makes appropriate choices (i.e., screen capture, image, video, text) and follows the established expectations for documenting findings.

1. The student fails to document findings throughout the investigation.
2. The student gathers documentation of his/her findings, but documentation is incomplete or does not follow all of the expectations established.
3. The student adequately documents findings for each component of the investigation and makes appropriate choices in selections.
4. The student uses a variety of appropriate methods for documentation and exceeds the established expectations.

Share phase

During the Share phase, make sure the student uses evidence from his/her own findings during the investigation to justify his/her reasoning.

The student adheres to established guidelines for presenting findings to the audience.

1. The student does not use evidence from his/her findings in connection with ideas shared during the presentation. The student does not follow established guidelines.
2. The student uses some evidence from his/her findings, but the justification is limited. Established guidelines are generally followed but may be lacking in one or more areas.
3. The student adequately provides evidence to justify his/her findings and follows established guidelines for presenting.
4. The student fully discusses his/her findings and thoroughly utilizes appropriate evidence to justify his/her reasoning while following all established guidelines.



Explore phase

The introductory video may set the stage for the following ideas to be reviewed and discussed with students for this project.

Introductory video

Over centuries, humans have created devices to prevent water from flooding populated areas:

1. Weather brings various types of precipitation during the year.
2. Sometimes, there is so much water that rivers and streams cannot hold it all.
3. Erosion is a natural phenomenon that happens often in areas that get a lot of precipitation.
4. Floodgates are devices that let water flow downstream in canals or rivers.
5. When there is regular precipitation, the floodgates are open to keep the reservoir level low.
6. In times of high precipitation, the floodgates are closed to fill the reservoir with the extra water.

You can compare the idea of floodgates to filling a bathtub:

- Opening the doors will allow more water from upstream to go down or from the faucet to the bathtub and then to the drain.
- Closing the floodgates completely will stop the water from draining away and would create a flood upstream—or fill your bathtub.

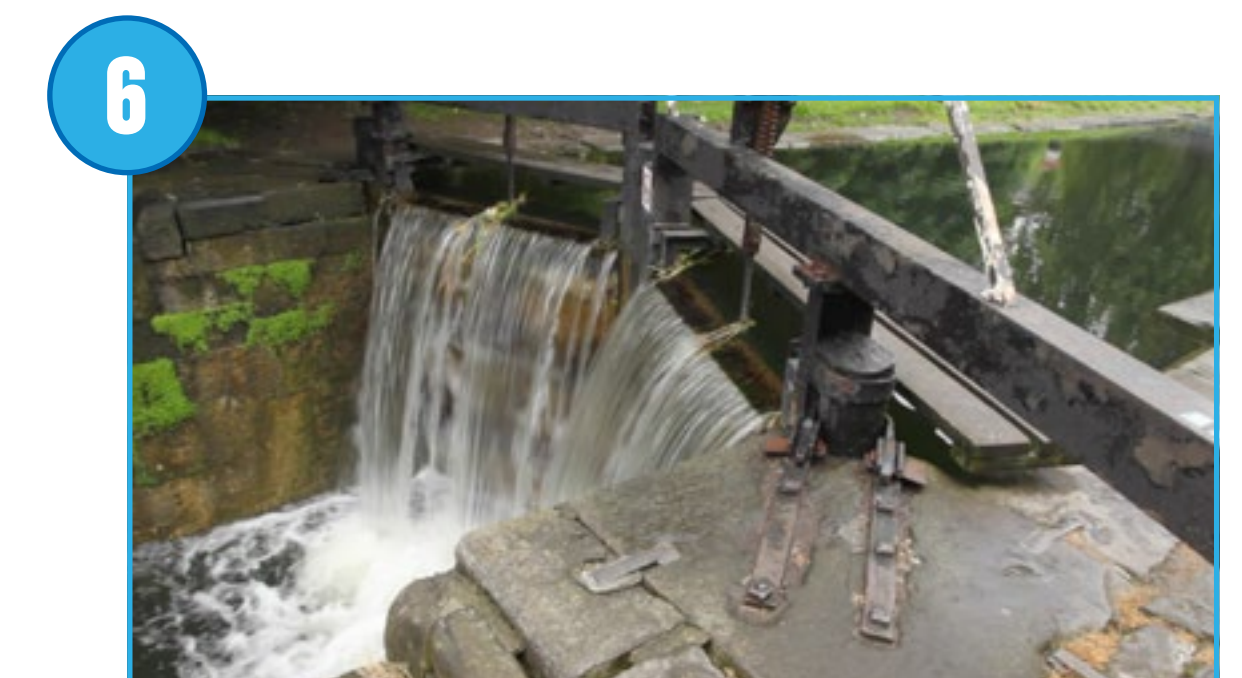
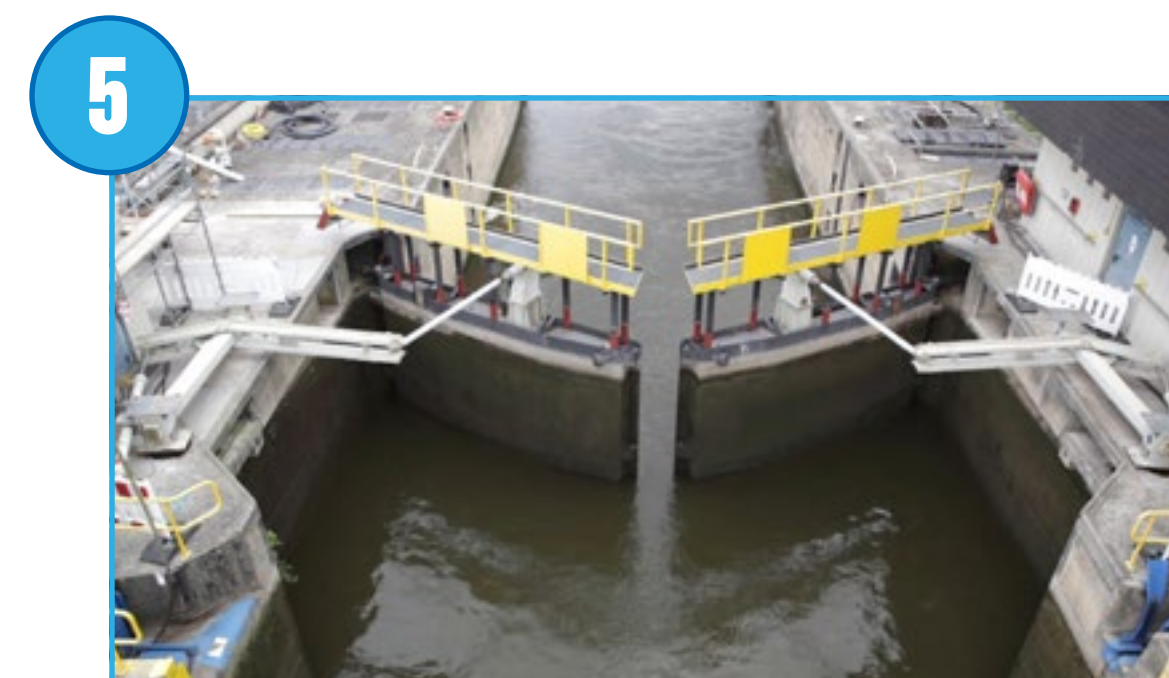
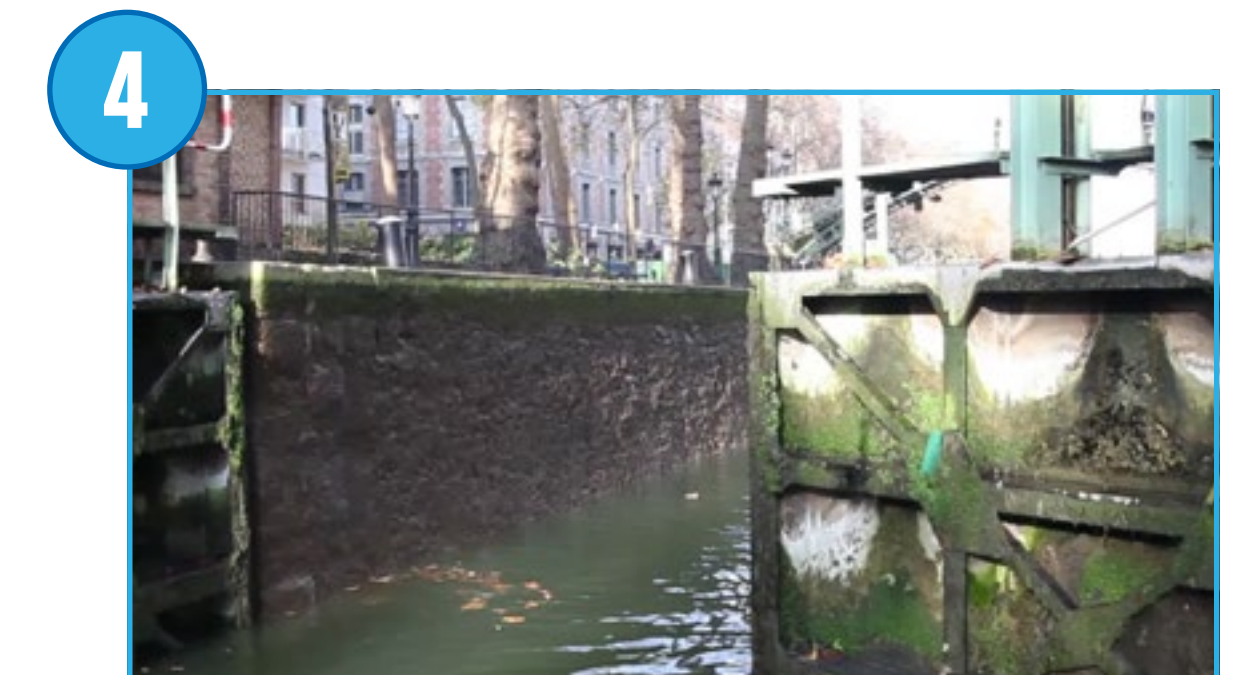
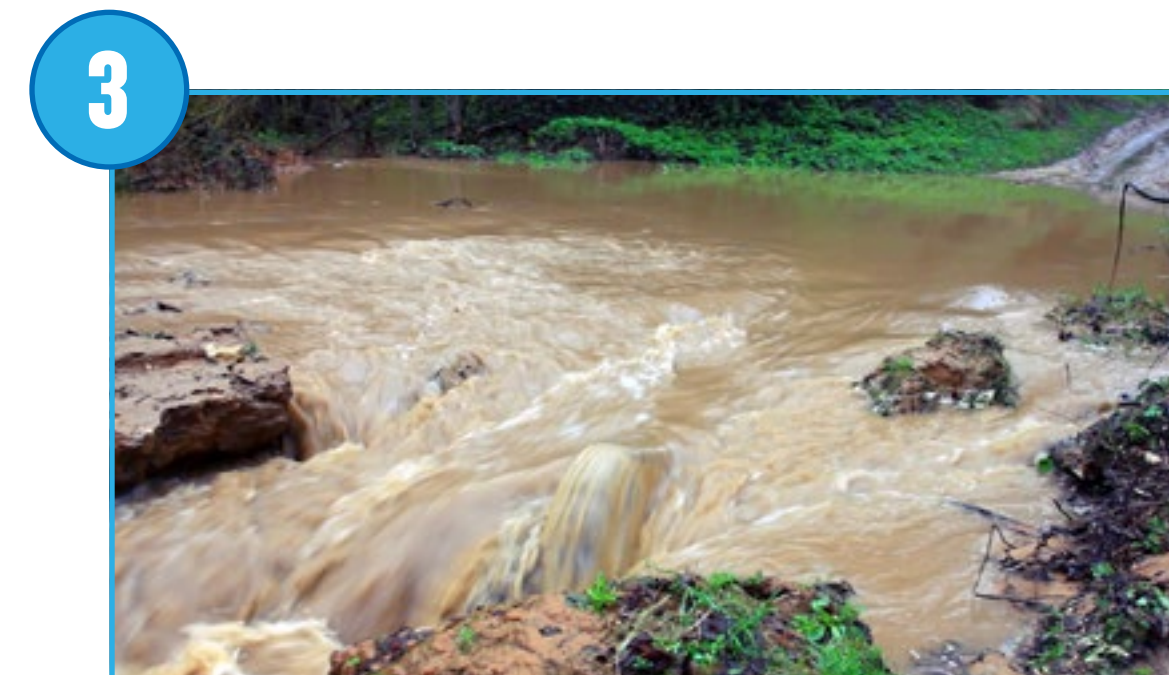
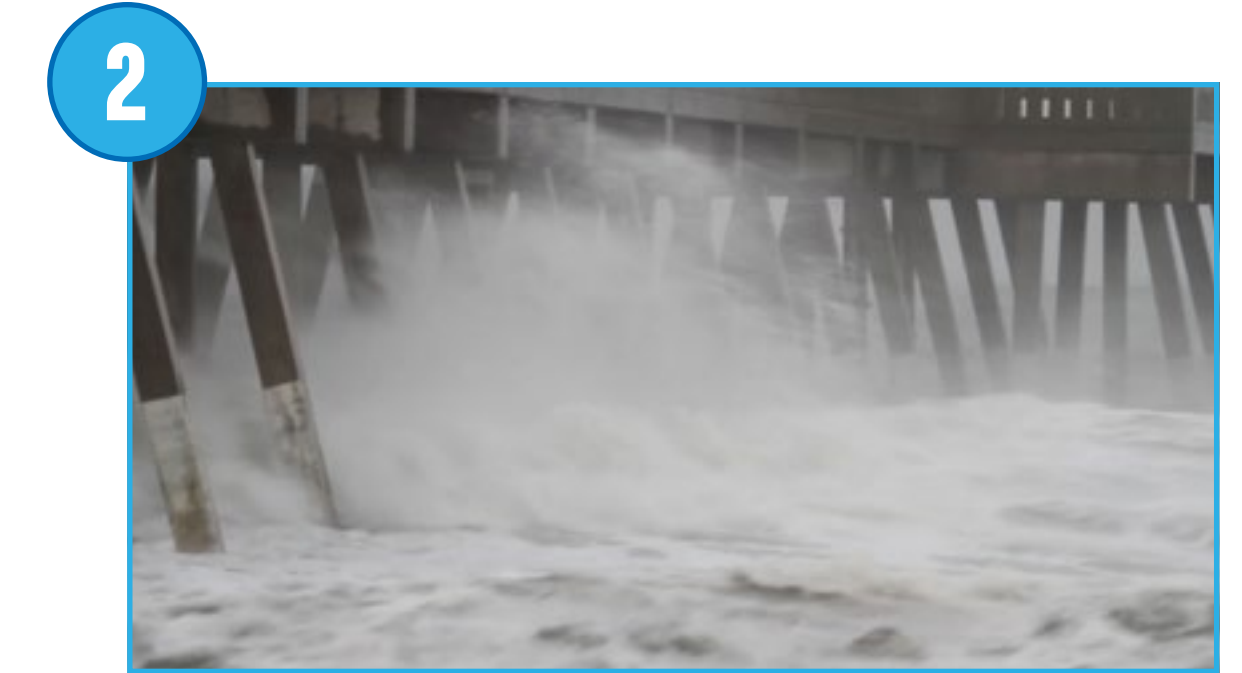
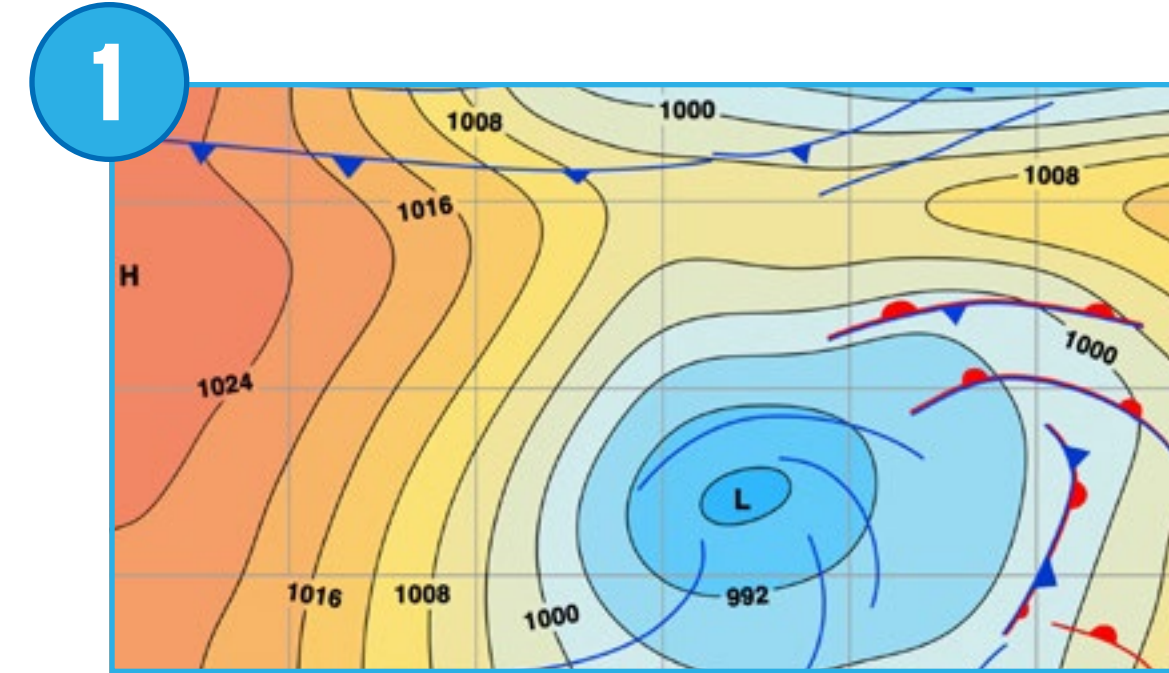



Explore phase

Questions for discussion

1. Describe precipitation levels for each season in your area using a bar graph.
The answer to this question will vary according to your location. Use descriptive words such as high rain season, low rain season, and flooding.
The bar should show high, low, or medium precipitation.
2. How does precipitation influence water levels in a river?
Precipitation is not the only factor influencing the water level of rivers, but generally:
 - High precipitation raises the water level.
 - Low precipitation lowers the water level.
3. List ways a flood can be prevented.
There are many ways humans prevent flooding: dikes, dams, trenches, reforestation, etc.
4. Imagine a device that can prevent flooding from happening.
The answer to this question will guide students to the design process.

Have your students collect their answers with text or pictures in the Documentation tool.

Other questions to explore

1. What is water erosion?
Water erosion is a natural process by which water changes the shape of the land.
2. How is this bar graph different from one in your own region?
The answer to this question will vary according to the student's location.



Create phase

Build and program a floodgate

Students will follow the building instructions to create a floodgate. This gate can be closed and opened using the motor.

1. Build a floodgate.

The module used in the project uses a bevel gear. This bevel gear can change the axis of rotation, allowing the floodgate to open and close.

2. Program the model to open and close the floodgate.

This program will display the image of the precipitation and turn the motor on one way for 2 sec. Then it will display the image of the sun and turn the motor on the other way for 2 sec.

► Important

The use of the bar graph should help students explain why they need to close or open the floodgate.

► Suggestion

Before your students start designing solutions, have them change the parameters of the program so they fully understand it.

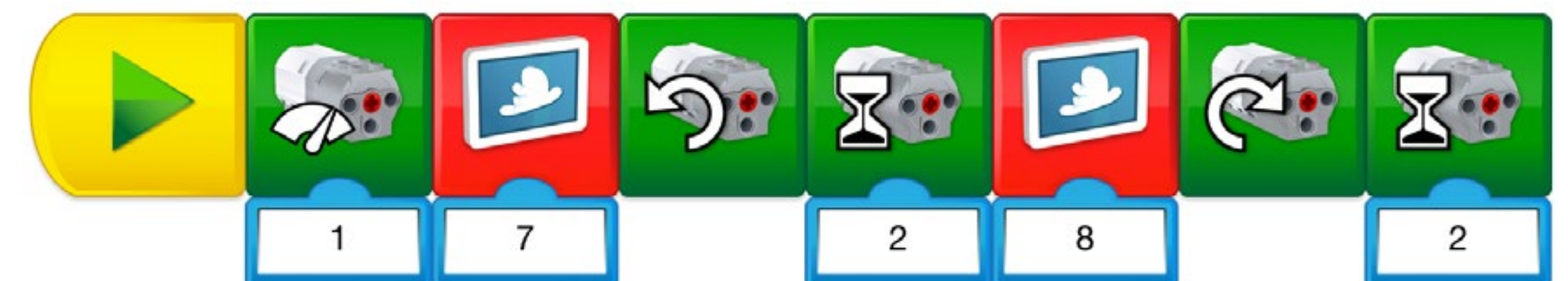



Create phase

Automate the floodgate

Using this model, students should be able to add sensors to the model to make the floodgate react to its environment. They should consider at least one of these options:

1. Add a Tilt Sensor handle to operate the gate.

A Tilt Sensor handle will let an operator on the ground open and close the door.

2. Add a Motion Sensor to detect rising water.

A Motion Sensor will let you open and close the door according to water levels. Use your hands or LEGO® bricks to simulate different water levels.

3. Add a Sound Sensor Input to activate emergency protocol.

The emergency protocol can be used to play a sound, flash the lights, send a text message, or close the floodgates.

► Important

It is important to note that because a student model will vary according to student choice, there are no building instructions or sample programs provided to students for this part of the project.

► Suggestion

If students need inspiration for these elements, you can always refer them to the Design Library.



Create phase

Use the “Design new solutions” section of the student project as an optional extension. Keep in mind that these tasks extend upon those of the “Design a solution” section and are designed for older or more advanced students.

Design further solutions

Flooding and erosion do not just happen anywhere.

1. Draw a map of the floodgate location, including the land and river areas:

- Ask your students to create a map or a display of the river with other elements, such as mountains, valleys, cities, etc.
- Ask them to describe where a floodgate might be used.
- Ask them to illustrate where the water is coming from and where it goes.

2. Find other uses for a floodgate.

You could use the floodgate in other situations than a flood. Have your students think of gates or a door in general.

Collaboration suggestion

The floodgate can also be used in a canal navigation scenario. Pair up teams so they can illustrate what might happen in a boat transportation sequence.

3. Program two floodgates to control navigation of water in and out of a section of the river.

Have your students describe and program the sequence for operating the floodgates.



Share phase

Complete the document

Have students document their projects in different ways:

- Ask students to take photos of each version they create. Get them to explain which is the best solution and provide evidence for their reasoning.
- Ask your students to compare these images with real-life images.
- Ask your students to record a video of themselves describing their projects.

Present results

In this specific project, have students present how their floodgate works with the use of a sensor.

To enhance students' presentations:

- Make sure they can explain why the floodgates can prevent water from changing the shape of the land.
- Ask them to put their explanation into context: Where is this happening?
In what season? Under what conditions?

Prevent Flooding

One possible way of sharing

Students in this class explain how a floodgate can prevent water from reshaping the land downstream.



Project 7

Drop and Rescue

This project is about designing a device to reduce the impacts on human, animals, and environment after an area has been damaged by a weather-related hazard.





Curriculum link

NGSS performance expectation

3-ESS3-1: Make a claim about the merit of a design solution that reduces the impacts of a weather-related hazard.

3-5-ETS1-2: Generate and compare multiple possible solutions to a problem based on how well each is likely to meet the criteria and constraints of the problem.

NGSS crosscutting concepts

Cause and effect

Common Core State Standards for English Language Arts

CCSS.ELA-Literacy.W.3.7: Conduct short research projects that build knowledge about a topic.

CCSS.ELA-Literacy.W.3.8: Recall information from experiences or gather information from print and digital sources; take brief notes on sources and sort evidence into provided categories.

CCSS.ELA-Literacy.SL.3.1.a: Come to discussions prepared, having read or studied required material; explicitly draw on that preparation and other information known about the topic to explore ideas under discussion.

CCSS.ELA-Literacy.SL.3.1.d: Explain your own ideas and comprehension in light of the discussion.

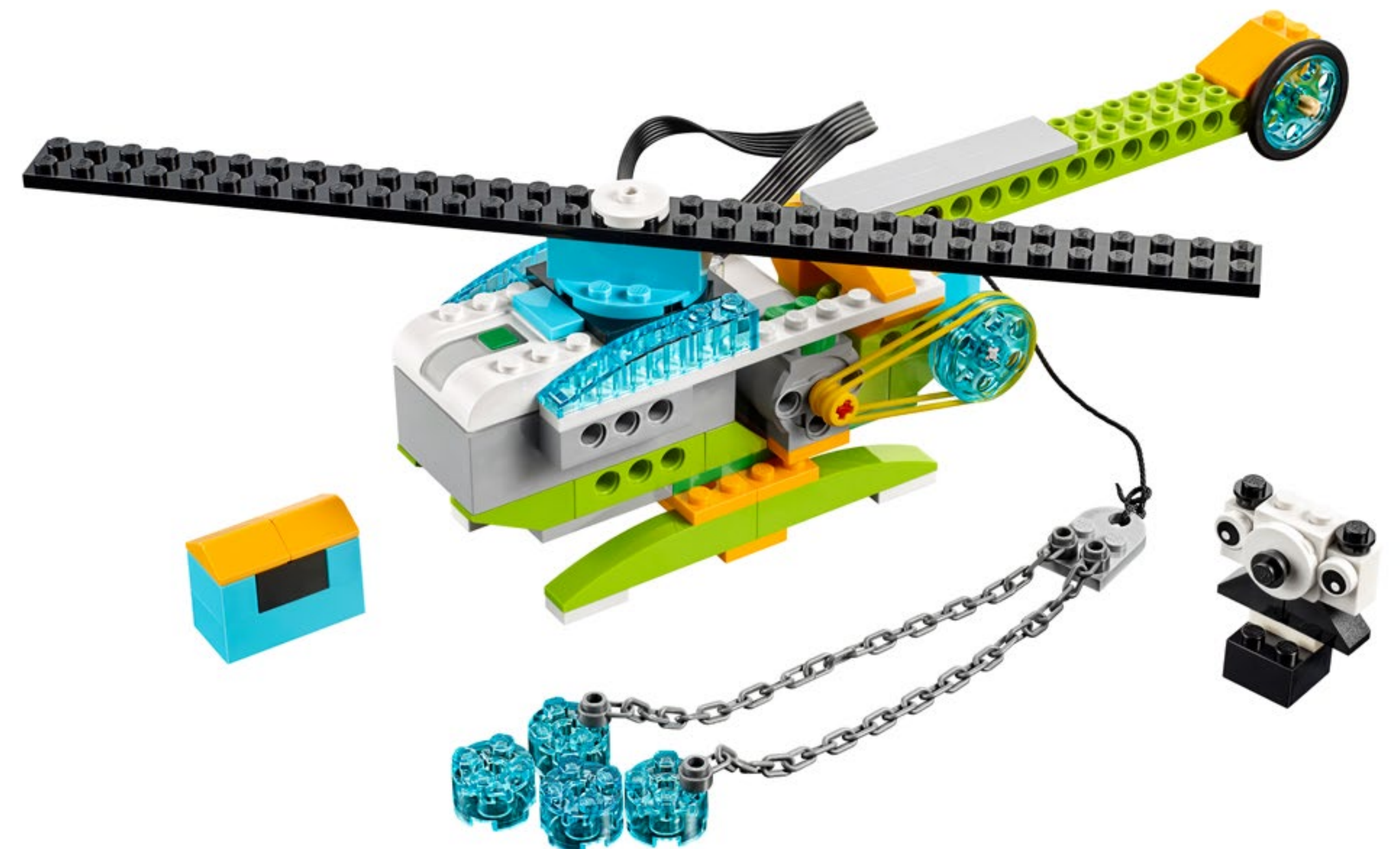



Quick glance: Plan this WeDo 2.0 project

Preparation: 30 min.

- Read the general preparation in the “Classroom Management” chapter.
- Read about the project so you have a good idea of what to do.
- Define how you want to introduce this project: Use the video provided in the project in the WeDo 2.0 Software, or use material of your own choice.
- Determine the end result of this project: the parameters to present and produce the document.
- Make sure timing allows for expectations to be met.

► Important

This project is a design brief. Please refer to the “WeDo 2.0 in Curriculum” chapter for further explanations of design practices.

Explore phase: 30–60 min.

- Start the project using the introductory video.
- Have a group discussion.
- Allow students to document their ideas for Max and Mia’s questions using the Documentation tool.

Create phase: 45–60 min.

- Get students to build the first model from the provided building instructions.
- Let them program the model with the sample program.
- Allow time for them to design two different prototypes for one of the rescue missions: relocate an endangered animal, drop materials to help people, or drop water to put out fires.

Create more phase (optional): 45–60 min.

- If you want, use this extra layer of the project for differentiation or for older students.

Share phase: 45 min. or more

- Make sure your students document the results of each mission.
- Have students share reasons for their particular design prototype for each mission.
- Ask them to discuss the engineering-based design process and ways that they had to change or adjust the prototypes.
- Have your students create their final presentations.
- Use different ways to let students share results.
- Have students present their project.

► Suggestion

Have a look at the following Open Projects after this one:

- [Cleaning the Ocean](#)
- [Space Exploration](#)



Differentiation

To ensure success, consider giving more guidance on building and programming, such as:

- Make sure they understand the problem they have to solve.
- Have them write down or record a video describing the problem.
- Explain engineering-based design.
- Explain how to use sensors.

Also, be specific on the way you would like them to present and document their findings, by having a sharing session among teams, for example.

Suggestion

For more experienced students, you may want to ask them to use the Tilt Sensor to control the up-and-down movement of the string.

Design further solutions

To design further solutions, ask students to design a completely new solution to the problem, moving away from the helicopter into something different.

Students' misconceptions

It is possible that students will only articulate experiences about what they can imagine within their own world. For example, coastal communities may only consider sea rescue. Have your students project themselves into another context to explore solutions.

Vocabulary

Stretcher

A special apparatus to move injured or endangered people or animals

Rescue

Responsive operations that save lives or present further danger to inhabitants of an affected area

Prototype

Early sample or model that is used to test a concept

Weather

The daily conditions of the atmosphere in terms of temperature, atmospheric pressure, wind, and moisture

Weather-related hazard

A group of natural hazards caused by weather



NGSS project assessment rubrics

You can use these assessment rubrics with the observation rubrics grid, which you will find in the “Assess with WeDo 2.0” chapter.

Explore phase

During the Explore phase, make sure the student is actively involved in the discussion, asking and answering questions, and can describe in their words the problem they have to solve in each mission.

1. The student is unable to provide answers to questions or participate in discussions adequately or adequately describe the problem to be solved in each mission.
2. The student is able, with prompting, to provide answers to questions or participate in discussions adequately or, with help, describe without detail the problem to be solved in each mission.
3. The student is able to provide adequate answers to questions and participate in class discussions and describe the problem to be solved in each mission.
4. The student is able to extend the explanations in discussion or describe the problem to be solved in each mission.

Create phase

During the Create phase, make sure the student is able to work on a team, talk about what they think is the best solution for each mission, and use the information collected in the Explore phase to suggest prototype solutions for each mission.

1. The student is unable to work well on a team to solve problems, discuss the best solution for each mission, or demonstrate the ability to use the engineering design process to solve problems.
2. The student is able to work on a team to solve problems, discuss the best solution for each mission, and, with help, demonstrate the use of the engineering design process to collect and use information to solve problems.

3. The student is able to work on a team to contribute to the discussion and demonstrate the use of the engineering design process to collect and use information to solve problems.
4. The student is able to work as a team leader and extend the use of engineering-based design to collect and use information to solve problems in many ways.

Share phase

During the Share phase, make sure the student can describe different solutions he/she developed for each mission, explain how one solution can solve the problem they have identified for each mission, and use important information from their project to create their final report.

1. The student is unable to engage in discussions about the mission and design, explain the solutions to the problems posed, or use the information to create a final project.
2. The student is able, with prompting, to engage in discussions about design processes as well as demonstrate with limited ability the use of information to solve real-world problems and create a project.
3. The student is able to engage in discussions about design processes or use the information gathered to produce a final project that present solutions for the posed problems.
4. The student is able to engage extensively in class discussions about the topic or use information gathered to create a final project that includes additional required elements.



ELA project assessment rubrics

You can use these assessment rubrics with the observation rubrics grid, which you will find in the “Assess with WeDo 2.0” chapter.

Explore phase

During the Explore phase, make sure the student can effectively explain his/her own ideas and comprehension related to the questions posed.

1. The student is unable to share his/her ideas related to the questions posed during the Explore phase.
2. The student is able, with prompting, to share his/her ideas related to the questions posed during the Explore phase.
3. The student adequately expresses his/her ideas related to the questions posed during the Explore phase.
4. The student uses details to extend explanations of his/her ideas related to the questions posed during the Explore phase.

Create phase

During the Create phase, make sure the student makes appropriate choices (i.e., screen capture, image, video, text) and follows the established expectations for documenting findings.

1. The student fails to document findings throughout the investigation.
2. The student gathers documentation of his/her findings, but documentation is incomplete or does not follow all of the expectations established.
3. The student adequately documents findings for each component of the investigation and makes appropriate choices in selections.
4. The student uses a variety of appropriate methods for documentation and exceeds the established expectations.

Share phase

During the Share phase, make sure the student uses evidence from his/her own findings during the investigation to justify his/her reasoning.

The student adheres to established guidelines for presenting findings to the audience.

1. The student does not use evidence from his/her findings in connection with ideas shared during the presentation. The student does not follow established guidelines.
2. The student uses some evidence from his/her findings, but the justification is limited. Established guidelines are generally followed but may be lacking in one or more areas.
3. The student adequately provides evidence to justify his/her findings and follows established guidelines for presenting.
4. The student fully discusses his/her findings and thoroughly utilizes appropriate evidence to justify his/her reasoning while following all established guidelines.



Explore phase

The introductory video may set the stage for the following ideas to be reviewed and discussed with students for this project.

Introductory video

Serious weather-related hazards can destroy areas very quickly and violently.

When that happens, animals and people can be in danger:

1. Lightning storms are responsible for a lot of natural fires.
2. When fire starts, it can destroy habitats very quickly.
3. Strong winds and floods can also be hazards.
4. In extreme cases, authorities send rescue missions.
5. Helicopters can be used to lift up and fly animals and people out of danger or bring in supplies to those in need.

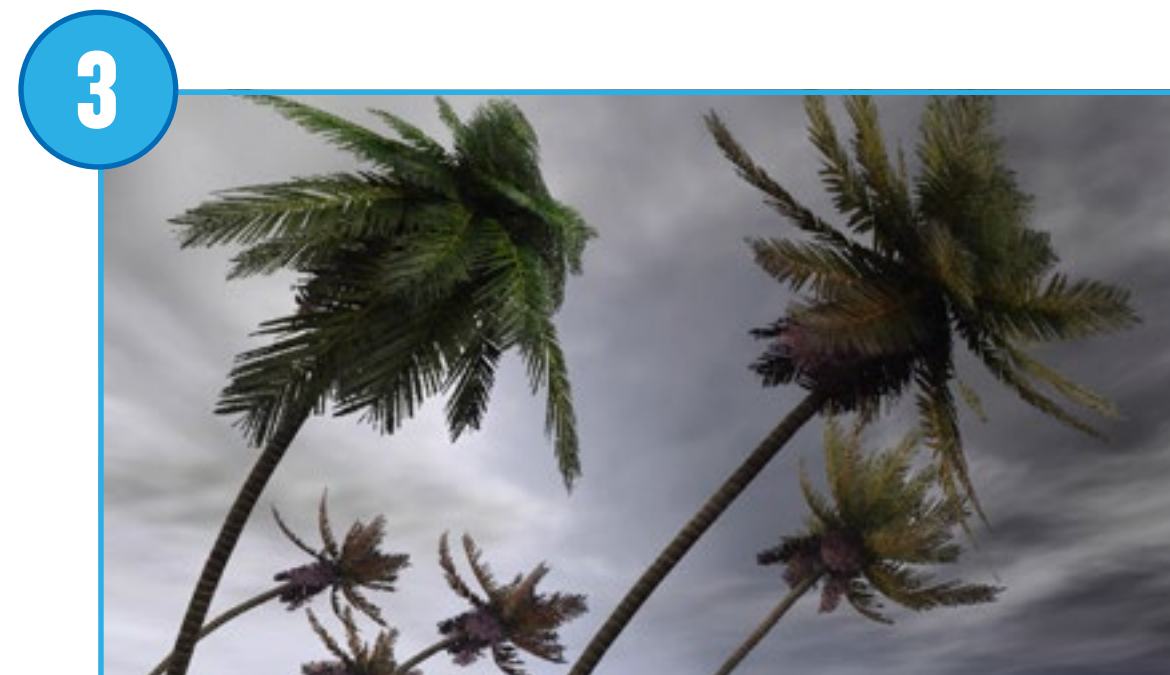
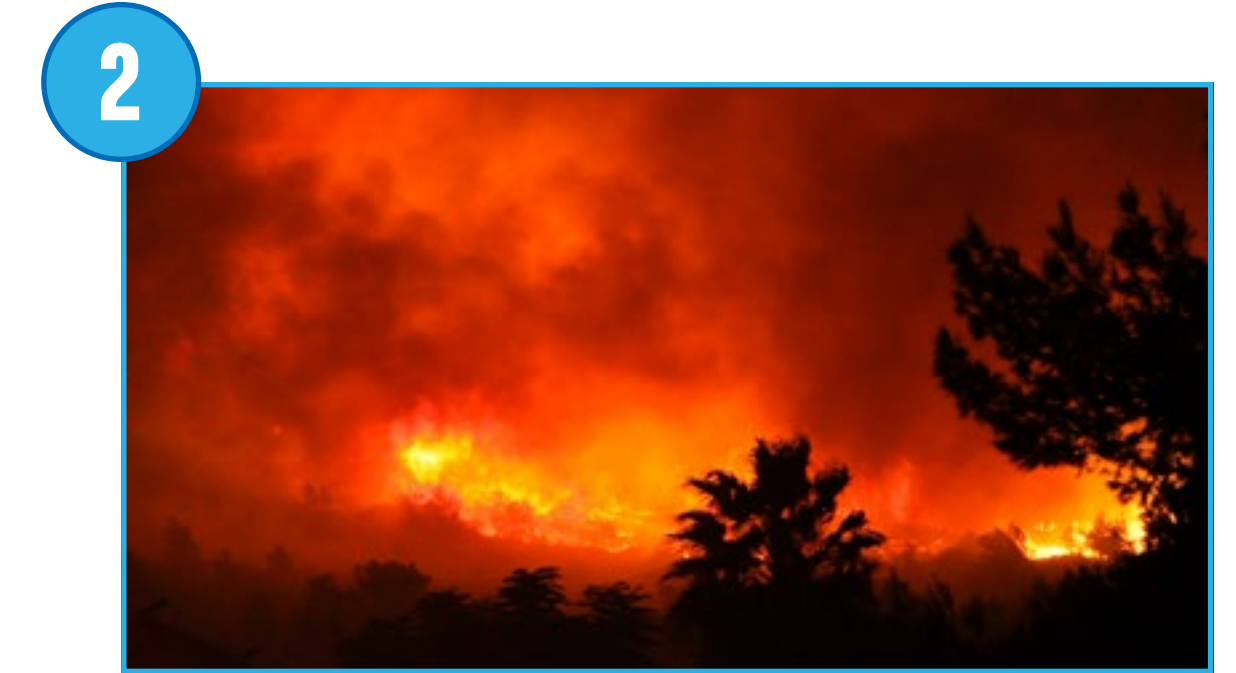
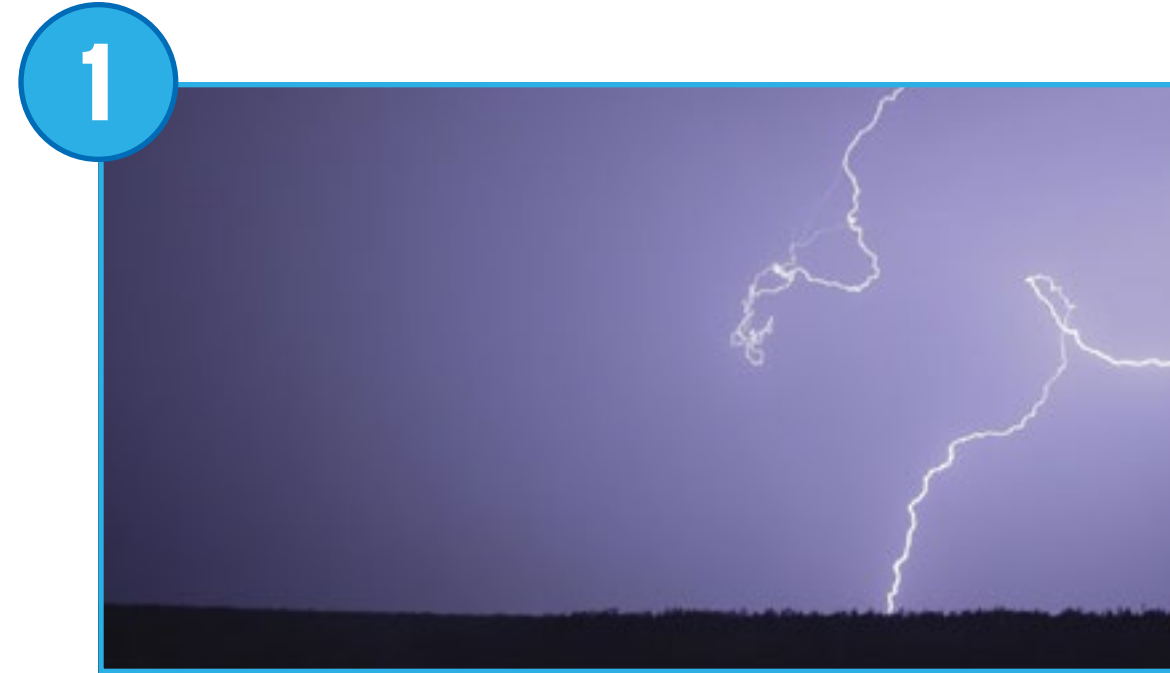



Explore phase

Questions for discussion

1. What kinds of weather-related hazards happen in your area or other areas?
The answer to this question will depend on your location, but some possible answers might be forest fires, floods, hurricanes, or tornados.
3. How do weather-related hazards affect animals or people?
The answer to this question will depend on your location, but the use of tools, machines, and robots would probably be part of the answer.
4. Describe different ways a helicopter can be used during a weather-related hazard.
A helicopter is useful because it can go to multiple locations. It can pick up or deliver people and materials.

Have your students collect their answers with text or pictures in the Documentation tool.



Create phase

Build and program a rescue helicopter

Students will follow the building instructions to create an exciting rescue helicopter.

1. Build a helicopter.

The model used in the project uses a pulley to transmit the movement from the motor axle to the string axle.

2. Program the helicopter to move up and down the string.

When the first Start Block is pressed, the motor turns on in one direction for 2 sec. The motor will start going in the other direction when the second Start Block is pressed.

▶ Suggestion

Before your students start designing solutions, have them change the parameters of the program so they fully understand it.





Create phase

From this model, students should be able to design their own drop or rescue device.

Students have to modify the helicopter so it can be used in a weather-damaged area, making sure their designs are safe, easy to use, and adapted to the situation. There is definitely more than one good answer to this challenge, but a good answer is something that can be linked to the criteria.

Have students build at least two solutions for one of the cases so they can compare them.

1. Build a device to relocate an endangered animal.

Students can build a platform, a box, or a stretcher to lift the animal. Make sure the animal does not fall out during transportation.

2. Build a device to drop materials to help people.

Students can build a basket, a net, or a stretcher to lower materials. Make sure nothing falls out during transportation.

3. Build a device to drop water to put out a fire.

This modification could lead to a new design for the helicopter body, using the motor to drop water instead of moving the string.

► Important

It is important to note that because a student model will vary according to student choice, there are no building instructions or sample programs provided to students for this part of the project.

► Important

Have the students build two solutions for one of the cases listed above. Make sure they compare their solutions according to the criteria also listed above.



Create phase

Use the “Design further solutions” section of the student project as an optional extension. Keep in mind that these tasks extend upon those of the “Use the model” section and are designed for older or more advanced students.

Design further solutions

In some cases, helicopters may not be used in rescue missions.

Describe in what case this situation might happen, and ask the students to think of a new solution to this problem. This new situation could be:

- A rescue during a tornado.
- A rescue after an avalanche.
- Providing vital resources during a drought period.

Have them reflect on what they learned in the previous part of the project.

Have them explain how they got better at finding a solution.

Collaboration suggestion

To have more than one team working on the same problem, ask your students to design solutions to a situation that has multiple rescuing aspects. For example, one team could focus on removing debris and the second team could pick up an animal or a person.



Share phase

Complete the document

Have students document their projects in a variety of ways. Some suggestions include:

- Ask students to take a photo of every version they have created and get them to explain the one they feel is the best solution and why.
- Ask your students to compare these images with real-life images.
- Ask your students to record a video of themselves describing their projects.

Present results

In this specific project, have students present two of their designs, and ask them to explain why these solutions meet the criteria or not.

To enhance students' presentations:

- Ask them to describe how their solution is used in the rescue mission they have chosen.
- Ask them to add some context to their explanation.
- Ask them to describe where this is happening, in what conditions, and some safety issues they needed to address.

Drop and Rescue

One possible way of sharing

Students in this class have designed a safe helicopter to transport aid in both drop and rescue missions for animals, people, and supplies.

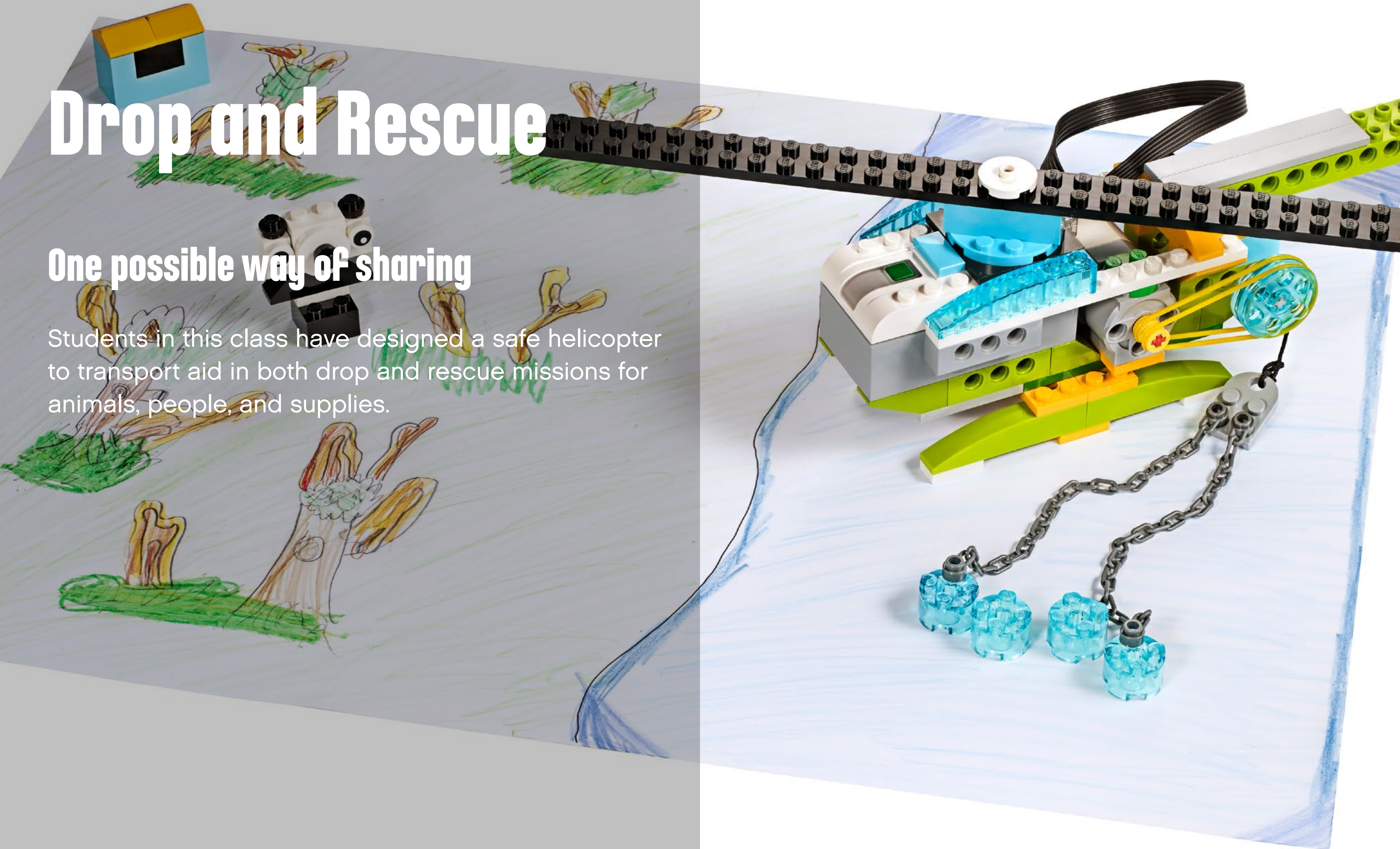



Project 8

Sort to Recycle

This project is about designing a device to use physical properties of objects, including their shape and size, to sort them.



Curriculum link

NGSS performance expectation

K-2-ETS1-2: Develop a simple sketch, drawing, or physical model to illustrate how the shape of an object helps it function as needed to solve a given problem.

2-PS1-1: Plan and conduct an investigation to describe and classify different kinds of materials by their observable properties.

Common Core State Standards for English Language Arts

CCSS.ELA-Literacy.SL.2.4: Tell a story or recount an experience with appropriate facts and relevant, descriptive details, speaking audibly in coherent sentences.





Quick glance: Plan this WeDo 2.0 project

Preparation: 30 min.

- Read the general preparation in the “Classroom Management” chapter.
- Read about the project so you have a good idea of what to do.
- Define how you want to introduce this project: Use the video provided in the project in the WeDo 2.0 Software, or use material of your own choice.
- Determine the end result of this project: the parameters to present and produce the document.
- Make sure timing allows for expectations to be met.

► Important

This project is a design brief. Please refer to the “WeDo 2.0 in Curriculum” chapter for further explanations of design practices.

Explore phase: 30–60 min.

- Start the project using the introductory video.
- Have a group discussion.
- Allow students to document their ideas for Max and Mia’s questions using the Documentation tool.

Create phase: 45–60 min.

- Let students build the recycling truck from the provided building instructions.
- Let them program the model with the sample program.
- Allow time for students to create different ways of sorting the two different objects.
- Consider having your students sketch their designs and modifications as part of this project.

Create more phase (optional): 45–60 min.

- If you want, use this extra layer of the project for differentiation or for older students.

Share phase: 45 min. or more

- Make sure your students document their prototypes—what works and what doesn’t—and explain what sorts of design challenges they encountered.
- Let your students share experiences in different ways.
- Have students present their project.
- Have your students create their final science reports.

► Suggestion

Have a look at the following Open Projects after this one:

- Cleaning the Oceans
- Extreme Habitats



Differentiation

To ensure success, consider giving more guidance on building and programming, such as:

- Give more time for students to understand how the first prototype works.
- Allow them time to create more than one prototype.
- Explain engineering-based design.

Also, be specific as to the way you would like them to present and document their findings, such as with a sharing session among teams, for example.

Design further solutions

For more experienced students, you may want to allow them extra time for building and programming to allow them to create different types of devices that sort according to other properties beyond shape. Ask them to use the design process to explain all the versions they made.

Students' misconceptions

Students will often confuse weight, mass, and volume. They will make the correlation that the heavier an object is, the bigger it is. They will also not connect gravity to the content. Be sure to formulate equations in the areas of weight, mass, and volume for students.

Vocabulary

Physical property

Characteristic of an object that can be observed or measured without changing its chemical composition, such as appearance, smell, or height

Recycle

To change waste items into usable materials

Sort

To arrange into groups by type

Efficient

Works in the best possible manner

Waste

Discarded material deemed no longer useful



NGSS project assessment rubrics

You can use these assessment rubrics with the observation rubrics grid, which you will find in the “Assess with WeDo 2.0” chapter.

Explore phase

During the Explore phase, make sure the student is actively involved in the discussions, asking and answering questions, and can explain how the properties of an object help them sort it.

1. The student is unable to provide answers to questions or participate in discussions adequately or adequately describe the properties of the object and how it may be sorted.
2. The student is able, with prompting, to provide answers to questions or participate in discussions adequately or, with help, describe the properties of the object and how it may be sorted.
3. The student is able to provide adequate answers to questions and participate in class discussions or describe the properties of the object and how it may be sorted.
4. The student is able to extend the explanations in discussion or describe the properties of the object and how it may be sorted.

Create phase

During the Create phase, make sure the student works well with his/her team, demonstrates the use of the engineering design process, and collects and uses information to solve problems.

1. The student is unable to work well on a team to solve problems, does not demonstrate the ability to use the engineering design process to solve problems.
2. The student is able to work on a team to solve problems or, with help, demonstrate the use of the engineering design process to collect and use information to solve problems.

3. The student is able to work on a team to solve problems or demonstrate the use of the engineering design process to collect and use information to solve problems.
4. The student works as a team leader or is able to extend the use of engineering design or collect and use information to solve problems in many ways.

Share phase

During the Share phase, make sure the student can explain how he/she solved the problem and communicates how he/she used the size of objects to sort them.

1. The student does not explain how he/she solved the problem and does not communicate how he/she sorted the objects by size.
2. The student can partially explain how he/she solved the problem and communicates, with prompting, some ideas on how he/she sorted objects by size.
3. The student can explain adequately how he/she solved the problem and communicates how he/she sorted objects by size.
4. The student can explain, in detail, how he/she solved the problem and communicates very clearly and thoroughly how he/she sorted objects by size.



ELA project assessment rubrics

You can use these assessment rubrics with the observation rubrics grid, which you will find in the “Assess with WeDo 2.0” chapter.

Explore phase

During the Explore phase, make sure the student can effectively explain his/her own ideas and comprehension related to the questions posed.

1. The student is unable to share his/her ideas related to the questions posed during the Explore phase.
2. The student is able, with prompting, to share his/her ideas related to the questions posed during the Explore phase.
3. The student adequately expresses his/her ideas related to the questions posed during the Explore phase.
4. The student uses details to extend explanations of his/her ideas related to the questions posed during the Explore phase.

Create phase

During the Create phase, make sure the student makes appropriate choices (i.e., screen capture, image, video, text) and follows the established expectations for documenting findings.

1. The student fails to document findings throughout the investigation.
2. The student gathers documentation of his/her findings, but documentation is incomplete or does not follow all of the expectations established.
3. The student adequately documents findings for each component of the investigation and makes appropriate choices in selections.
4. The student uses a variety of appropriate methods for documentation and exceeds the established expectations.

Share phase

During the Share phase, make sure the student uses evidence from his/her own findings during the investigation to justify his/her reasoning.

The student adheres to established guidelines for presenting findings to the audience.

1. The student does not use evidence from his/her findings in connection with ideas shared during the presentation. The student does not follow established guidelines.
2. The student uses some evidence from his/her findings, but the justification is limited. Established guidelines are generally followed but may be lacking in one or more areas.
3. The student adequately provides evidence to justify his/her findings and follows established guidelines for presenting.
4. The student fully discusses his/her findings and thoroughly utilizes appropriate evidence to justify his/her reasoning while following all established guidelines.



Explore phase

The introductory video may set the stage for the following ideas to be reviewed and discussed with students for this project.

Introductory video

Recycling material is one of the 21st century's biggest challenges. Recycling can give a second life to the materials that you use. Getting more people to consistently recycle their waste is a challenge, and one way to encourage more widespread recycling is to make sorting methods more efficient:

1. People must adopt behavior that discourages the throwing away of waste into the same place.
2. Materials typically must be sorted at the beginning of the recycling process, and many recyclable materials arrive at recycling centers all mixed together.
3. People or machines can separate waste according to their kind and put all the paper, plastic, metal, and glass together.
4. When a machine is used to sort objects, it needs to use one of the object's physical characteristics, such as weight, size, shape, or even its magnetic properties, to process them.

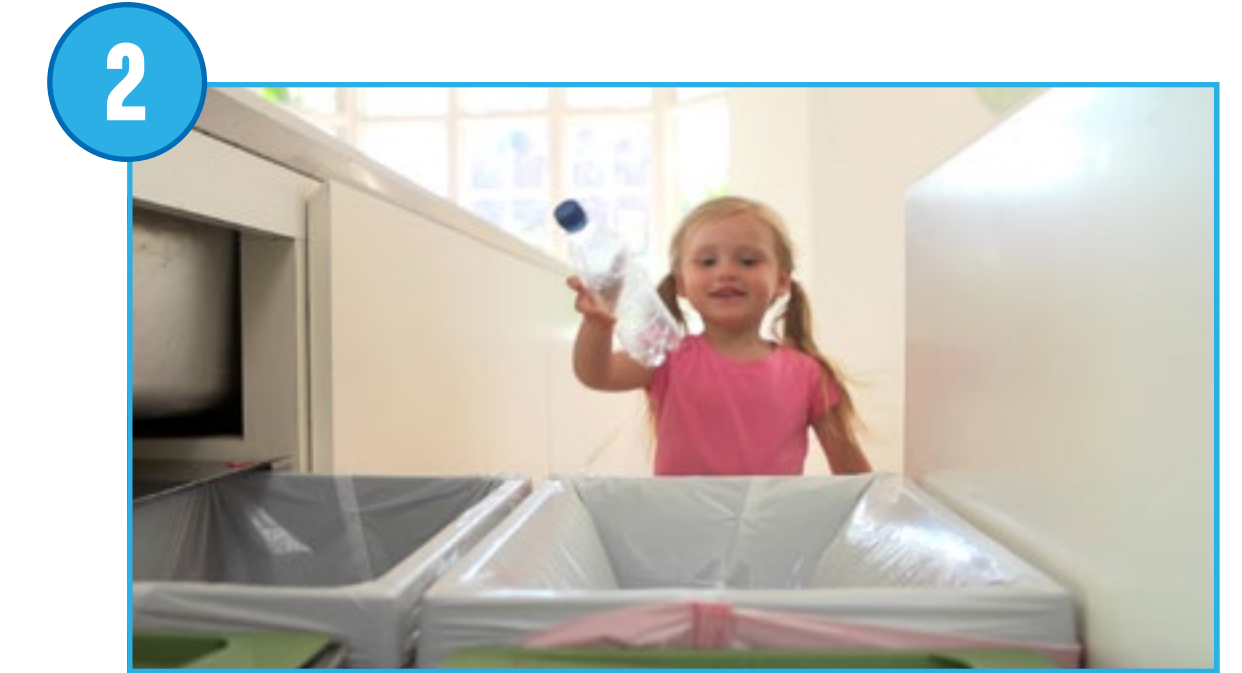
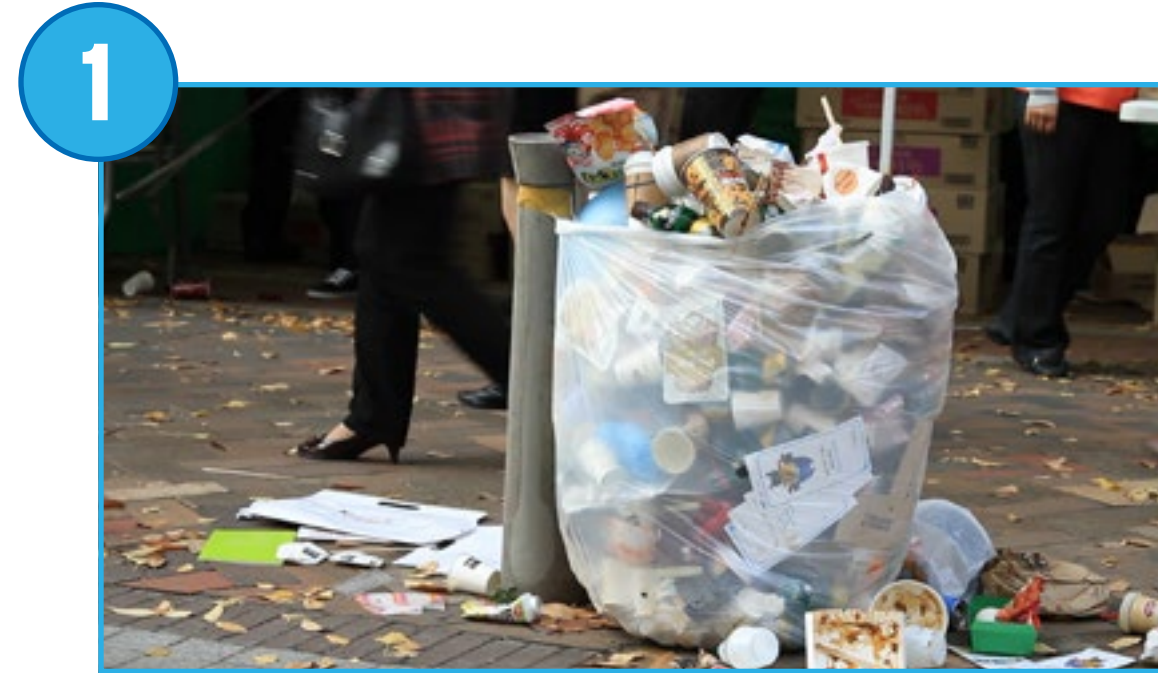



Explore phase

Questions for discussion

1. What does it mean to recycle?

Recycling is a process for making waste materials into something new.

Commonly recycled items include paper, plastic, and glass.

2. How is recyclable material sorted in your area?

Describe, with your students, if the materials are sorted by hand or machine.

Ask students if they sort recycling at home or if they sort anything else at home.

3. Imagine a device that can sort waste according to its shape.

The answer to this question will guide students to the design process.

Have your students collect their answers with text or pictures in the Documentation tool.

Other questions to explore

1. Where does your recycling material go?

The answer to this question will be different according to your location, but most likely, materials will go to the local recycling facility. Nonrecyclable material will go to a different location, such as a landfill or an incinerator.



Create phase

Build and program a truck to sort recyclable objects

Students will follow the building instructions to create a sorting truck and the objects.

1. Build a sorting truck.

The model used in the project uses a pulley system to flip the truck load on an axis. At first, both parts should be able to go through even though they are different shapes. Later, students will be challenged to modify the design so that the objects are sorted by size.

2. Program the truck bed.

This program will turn the motor on in one direction for 1 sec. to make sure the bed is completely at its reset position. It will wait 3 sec. for the boxes to be loaded by the student, play a machine sound, and then flip the bed to drop the boxes.

► Important

Students may have to adjust the power level of the motor in order for this program to work. Motors can vary from one to another.

► Suggestion

Before your students start their investigation, have them change the parameters of the program so they fully understand it.





Create phase

Design another solution

From this model, students should be able to change the design of the truck load to sort the boxes into two different groups according to their shape. Allow students a lot of flexibility. There are simple and more complex solutions to this problem that may involve changes to the design of the sorter, the program, or a combination of both.

Solution ideas

1. Modify the truck to sort the boxes.

By removing the LEGO® back plate of the truck, one box should be able to fall into the first hole while the other box slides off the back due to its shape. Other designs may work just as well.

2. Use the Motion Sensor to sort.

By placing the Motion Sensor on the side of the load in the proper position and by creating the right program, the sensor can detect objects based on size.

3. Sort the boxes outside the truck.

This solution would require building something else in addition to or instead of the truck. The boxes can be dropped at the factory and sorted in another way.

▶ Important

It is important to note that because a student model will vary according to student choice, there are no building instructions or sample programs provided to students for this part of the project.

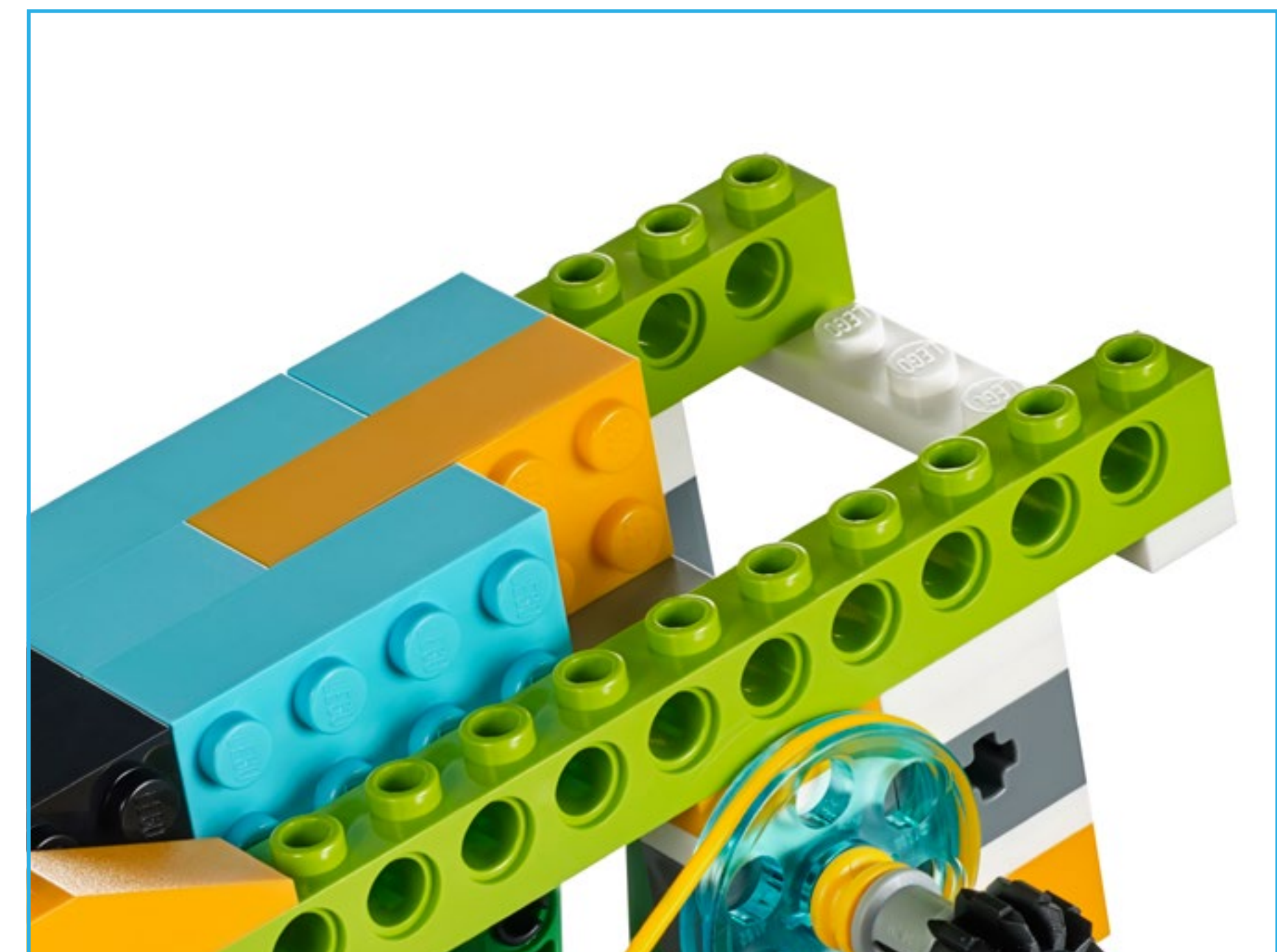
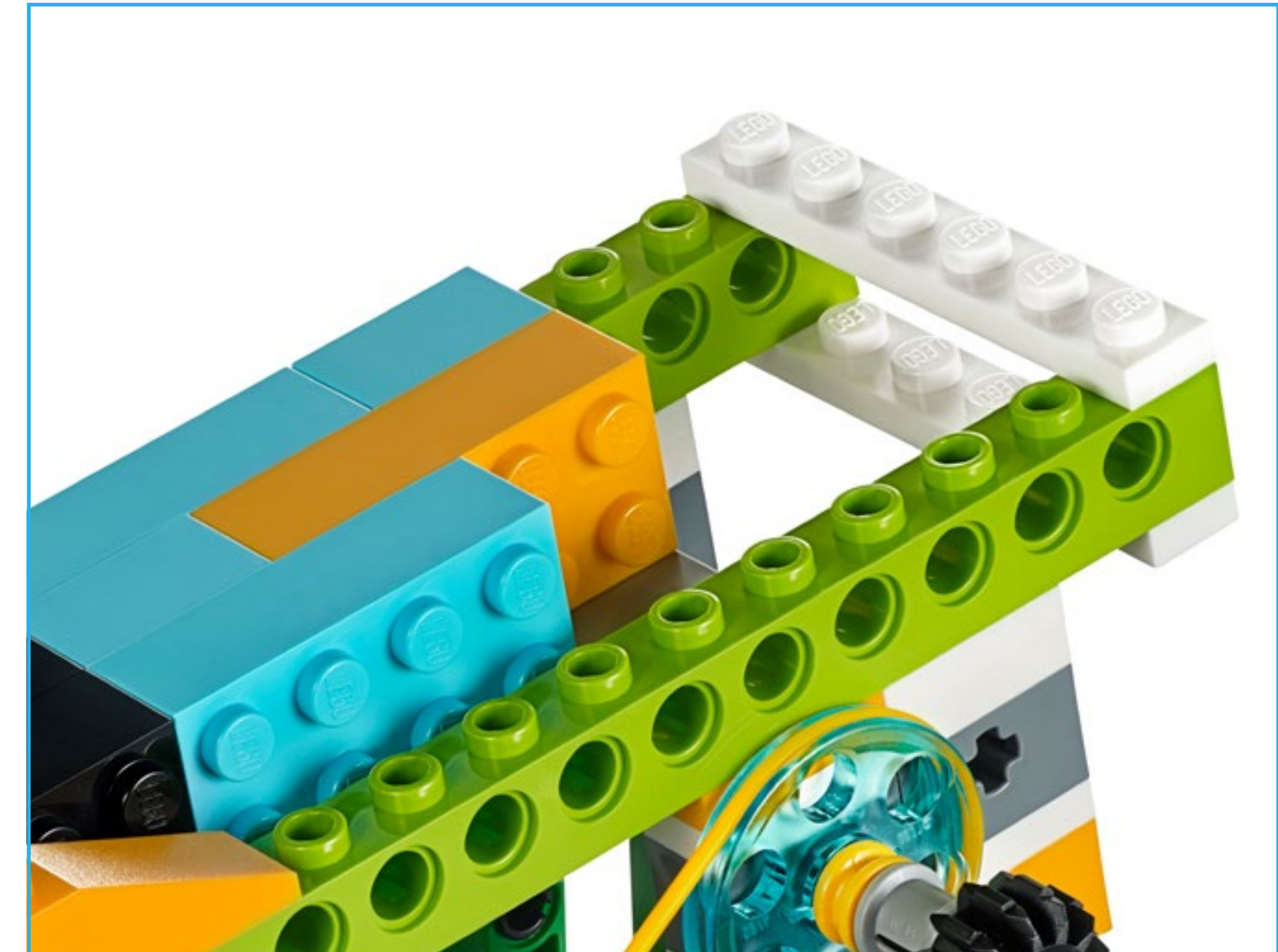



Create phase

Use the “Design further solutions” section of the student project as an optional extension. Keep in mind that these tasks extend upon those of the “Use the model” section and are designed for older or more advanced students.

A next step to this design project could be to ask students to design a solution for a more complex problem.

Design further solutions

Ask students to design a third object to sort. In order to sort items, students will probably have to move away from the truck model and design another type of device:

1. Sort the objects using a conveyor belt.
2. Sort the objects using a robot arm.
3. Sort the objects using two different devices.

Note that it should not be important if the device works perfectly or even that students find a successful solution. The important part is that the reasoning behind the sorting principles is well-articulated as students apply principles of engineering design.

Collaboration suggestion

By grouping teams together, students will get more options to create sorting strategies. You could have one team sort some of the objects and then require the second team to sort them even further. For example, the first team could sort small objects from the medium and large ones. The second team would then sort the medium from the large.



Share phase

Complete the document

Have students document their project in several ways:

- Ask students to take a picture of every version they have created and ask them to explain the most successful solution or the one with the most potential.
- Ask teams of students to compare and contrast their designs with each other.
- Ask students to include in their documentation an explanation of how an object could be sorted by shape and how the shape of the object was important to the solution.

Present results

Students should describe how their solution is used to sort objects according to their shape.

To enhance students' presentations:

- Have students present how they worked toward solving this problem.
- Have them explain the challenges they encountered and how they worked to modify their designs and programs as a result.
- Ask them to describe the context around their explanation:
- Discuss if this solution is applicable to real life.

Sort to Recycle

One possible way of sharing

Students in this class have designed different ways to sort objects according to their shapes.

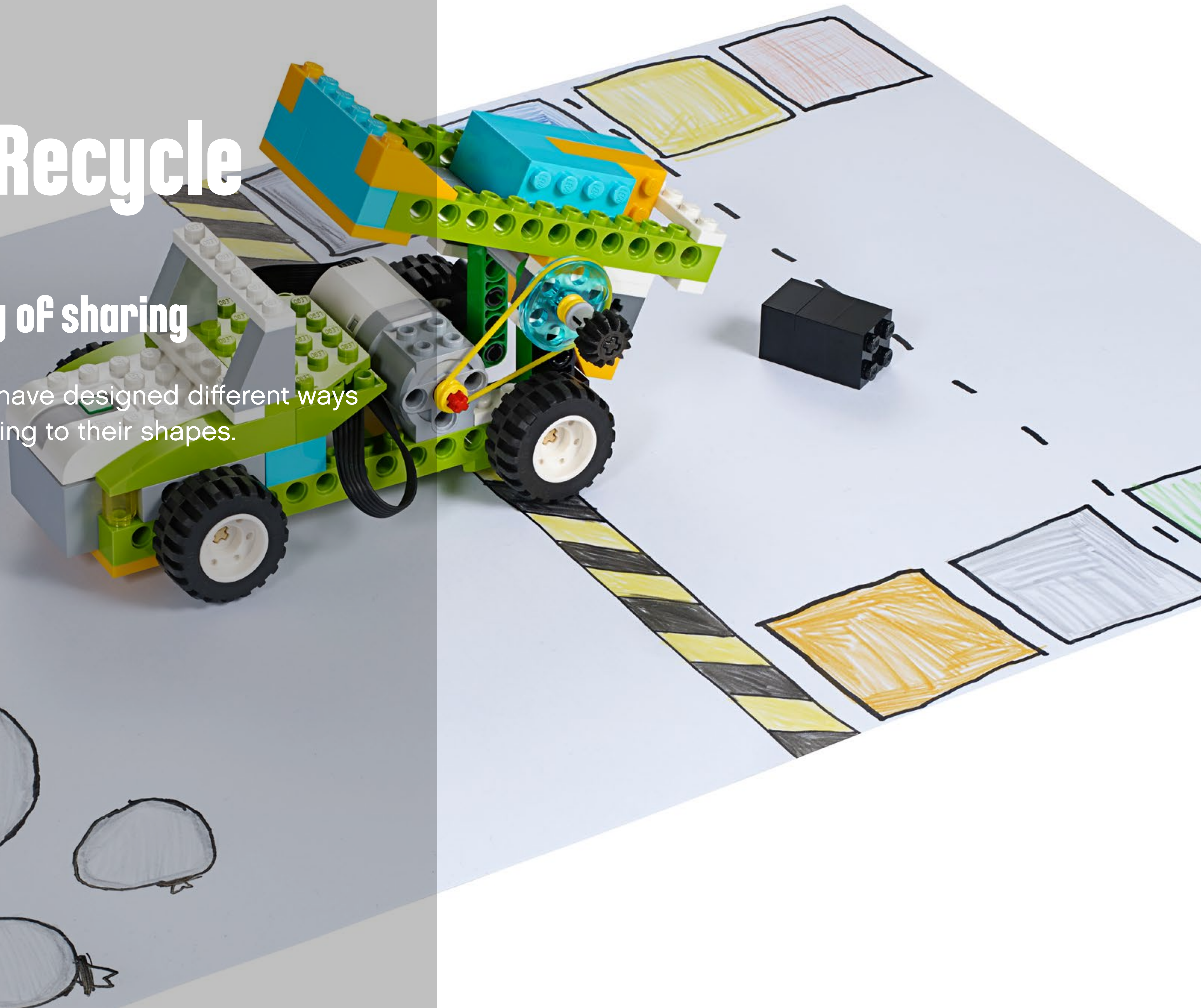
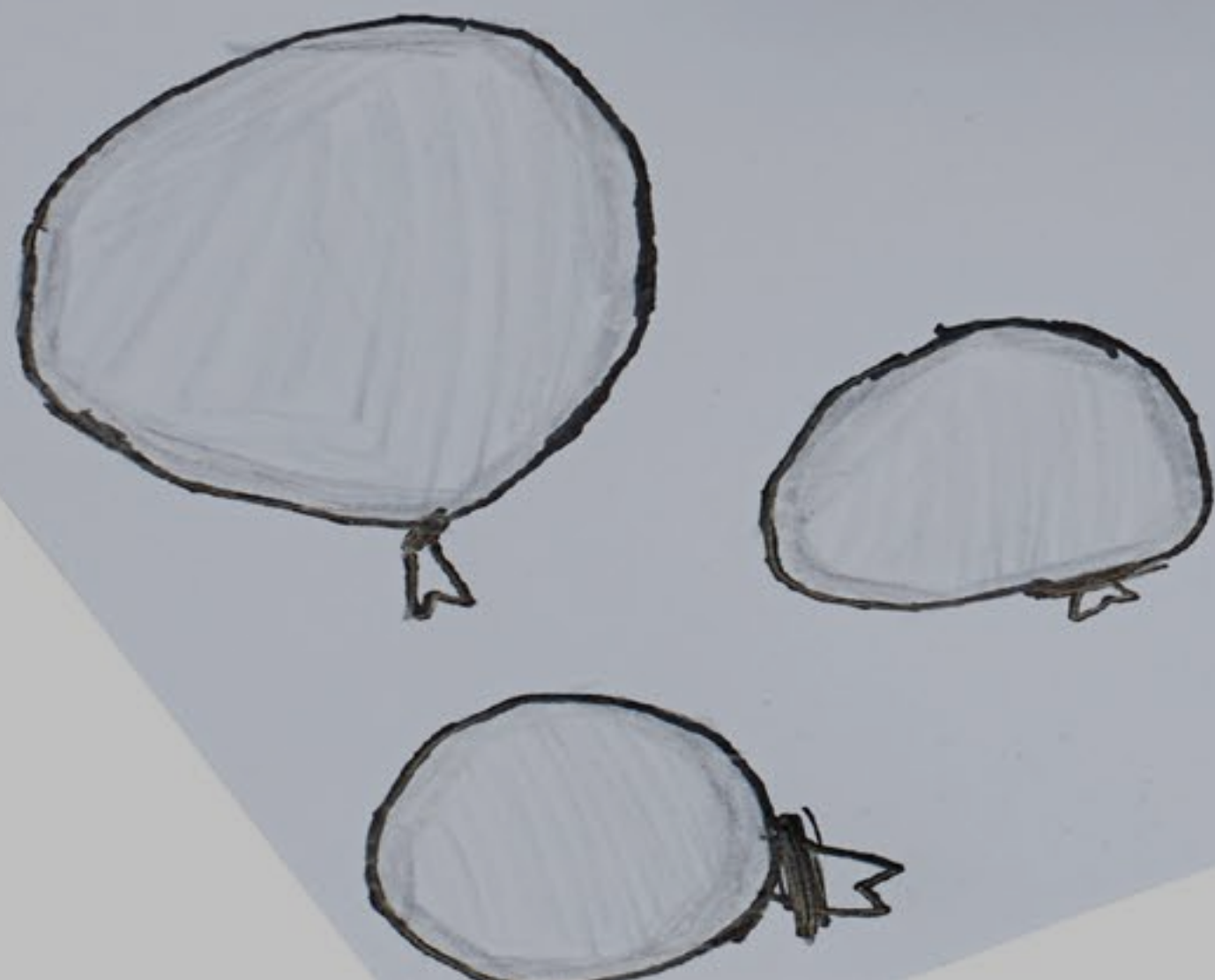

Open Projects overview

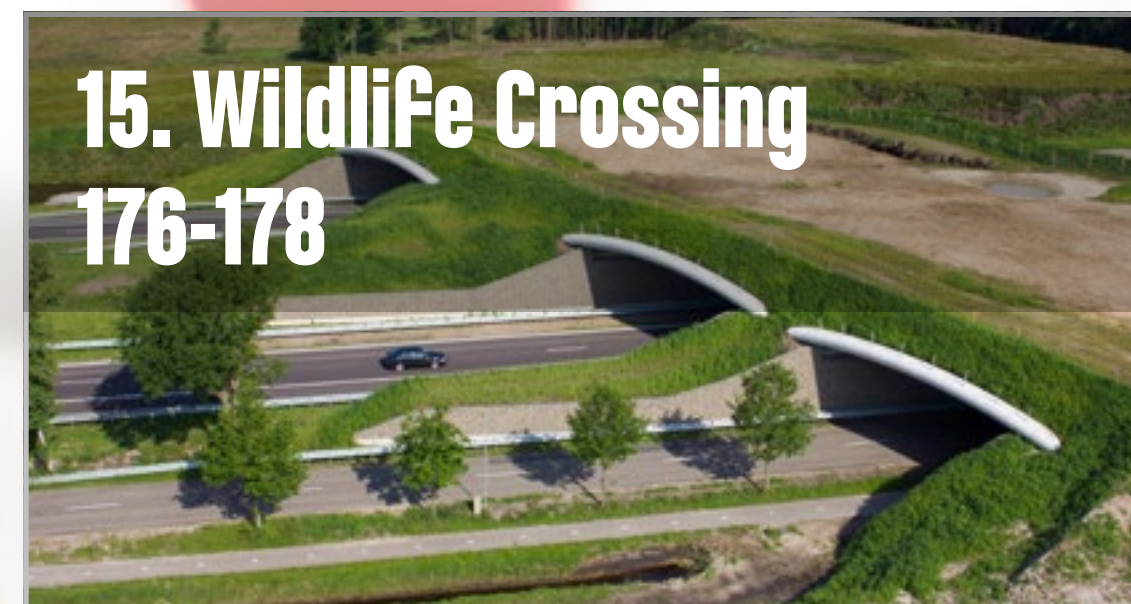

Project 9

Predator and Prey

This project is about modeling a LEGO® representation of the behavior of predators and their prey.





Curriculum link

NGSS

3-LS4-3: Construct an argument with evidence that in a particular habitat some organisms can survive well, some survive less well, and some cannot survive at all.

Common Core State Standards for English Language Arts

CCSS.ELA-Literacy.SL.3.1.D: Explain their own ideas and comprehension in light of the discussion.

CCSS.ELA-Literacy.W.3.1.B: Provide reasons that support the opinion.

Crosscutting concepts

Cause and effect

Explore phase

Predators share fascinating dynamic relationships with their prey. They have evolved over centuries to improve as hunters and trappers. This has forced prey to adapt in order to evade predators and survive.

Let students explore the developing relationships between different sets of predators and their prey.



Create phase

Students create a predator or prey model in order to describe the relationship between a predator and its prey.

Let students explore the Design Library so they can choose a model for inspiration. Then allow them to experiment and create their own solutions, modifying any basic model as they see fit.

Suggested Design Library base models include:

- Walk
- Grab
- Push

▶ Suggestion

Have teams work in pairs, with one team modeling a predator and the other team the prey.

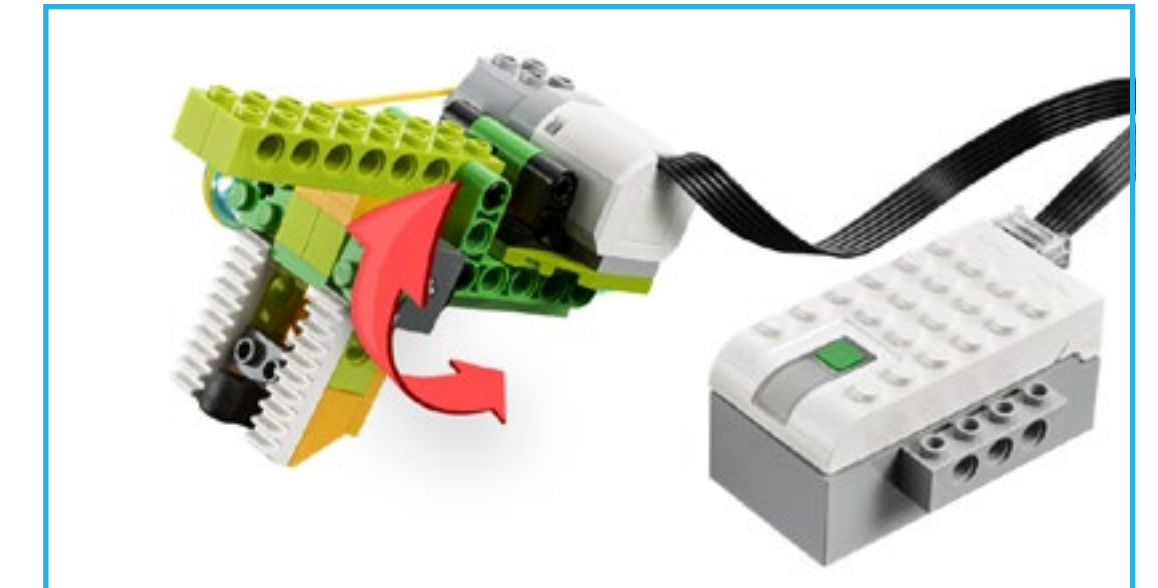
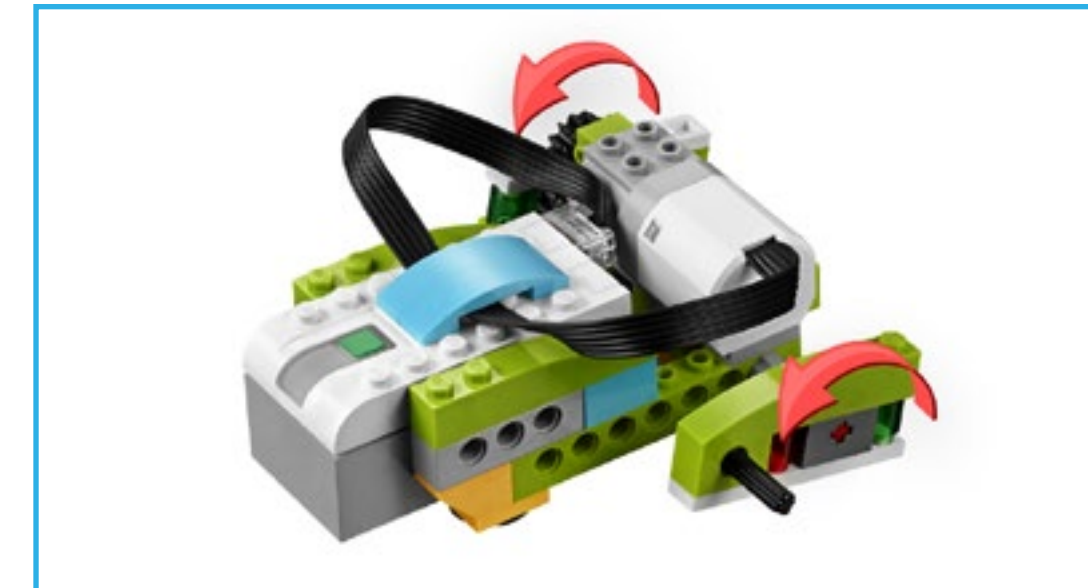

Share phase

Students should present their predator or prey models, explaining how they have represented the relationship between two species. They could use research and portfolio documentation to support their explorations and ideas.

Assessment

Ensure that students explain the different strategies the chosen predator uses to attract and catch its prey.

Project 10

Animal Expression

This project is about modeling a LEGO® representation of various communication methods in the animal kingdom.





Curriculum link

NGSS

3-LS4-2: Use evidence to construct an explanation for how the variations in characteristics among individuals of the same species may provide advantages in surviving, finding mates, and reproducing.

4-LS1-2: Use a model to describe that animals receive different types of information through their senses, process the information in their brain, and respond to the information in different ways.

4-PS4-3: Generate and compare multiple solutions that use patterns to transfer information.

Common Core State Standards for English Language Arts

CCSS.ELA-Literacy.SL.3.1.D: Explain their own ideas and comprehension in light of the discussion.

Crosscutting concepts

Cause and effect, patterns

Explore phase

Bioluminescence is the production of light by living organisms, such as fireflies, shrimp and deep sea fish. Bioluminescent creatures use this ability to glow for a variety of purposes, including camouflage, luring prey, and communicating. Other animals would use sounds and movements to communicate.

Let students explore these different social interactions to determine how these types of communication help them to survive, find mates, and reproduce.



Create phase

Students create a creature and illustrate their method of communication. The model should display one specific type of social interaction, such as light, movement, or sound.

Let students explore the Design Library so they can choose a model for inspiration. Then allow them to experiment and create their own solutions, modifying any basic model as they see fit.

Suggested Design Library models include:

- Tilt
- Wobble
- Walk

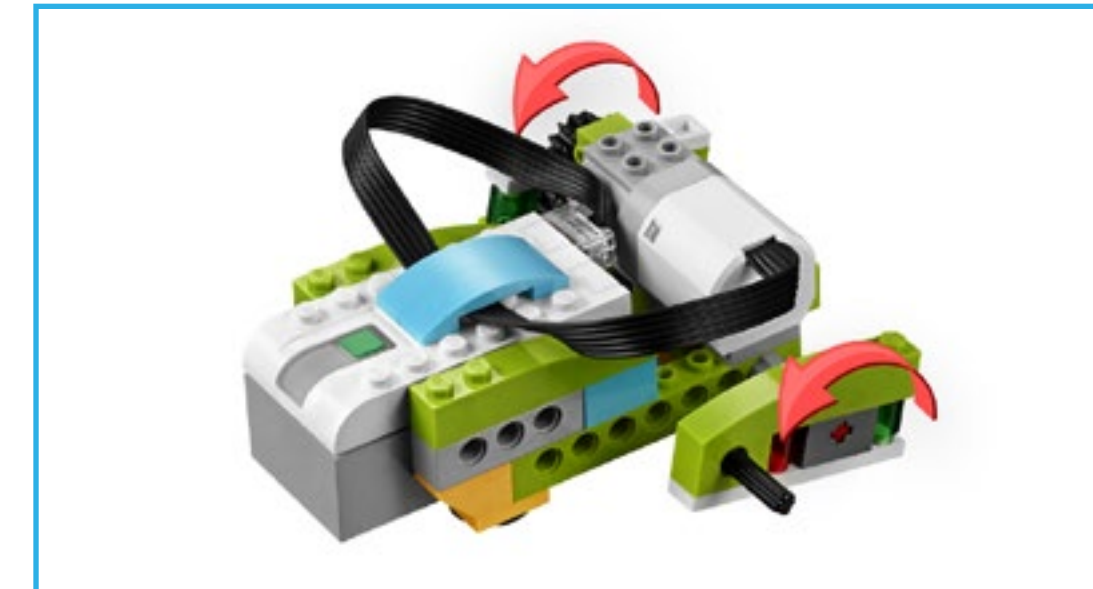
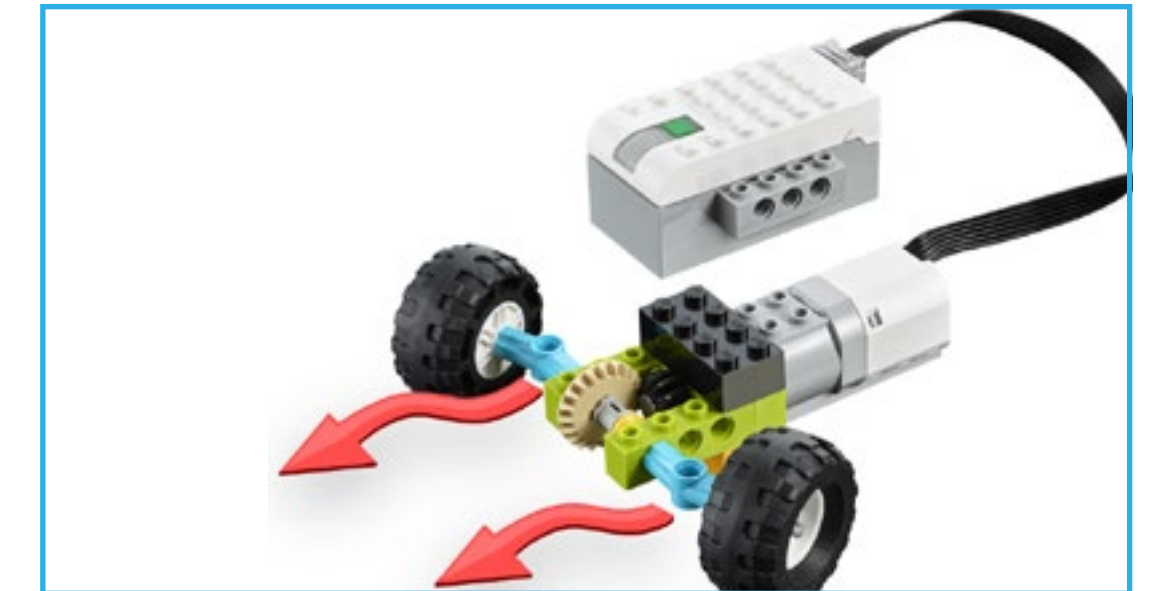

Share phase

Students should present their models, explaining how they represent a method of communication. They could use research and portfolio documentation to support their explorations and ideas.

Assessment

Ensure that students explain how the chosen method of communication creates social interaction. Ask them to say why the animals interact in this way. Some research regarding social interaction of animals might be necessary.

Project 11

Extreme Habitats

This project is about modeling a LEGO® representation of the influence of habitat on the survival of some species.





Curriculum link

NGSS

2-LS4-1: Make observations of plants and animals to compare the diversity of life in different habitats.

3-LS3-2: Use evidence to support the explanation that traits can be influenced by the environment.

3-LS4-1: Analyze and interpret data from fossils to provide evidence of the organisms and the environments in which they lived long ago.

Common Core State Standards for English Language Arts

CCSS.ELA-Literacy.SL.3.1.D: Explain their own ideas and comprehension in light of the discussion.

CCSS.ELA-Literacy.W.3.1.B: Provide reasons that support the opinion.

CCSS.ELA-Literacy.RI.3.3: Describe the relationship among a series of historical events, scientific ideas or concepts, or steps in technical procedures in a text, using language that pertains to time, sequence, and cause/effect.

Crosscutting concepts

Cause and effect, scale, proportion, and quantity

Explore phase

Fossils reveal a lot about why animals were able to survive in their surroundings. Habitat, climate, food, shelter, and available resources all contribute to the success of a species.

Let students explore both carnivores and herbivores and what their fossils tell us about how they lived. They could consider how some species developed to survive into the modern era. For example, have students build a flying or climbing dinosaur who nests in the treetops to protect their eggs or a crocodile to show how it uses its body, tail, and jaw in combination with its water habitat.

Alternatively, students could look at extreme habitats or even fictional habitats, as long as they are able to make the link between the habitat and their creature.



Create phase

Students create both a creature and the habitat they live in, showing how the creature has adapted to its surroundings.

Let students explore the Design Library so they can choose a model for inspiration. Then allow them to experiment and create their own solutions, modifying any basic model as they see fit.

Suggested Design Library models include:

- Crank
- Flex
- Reel

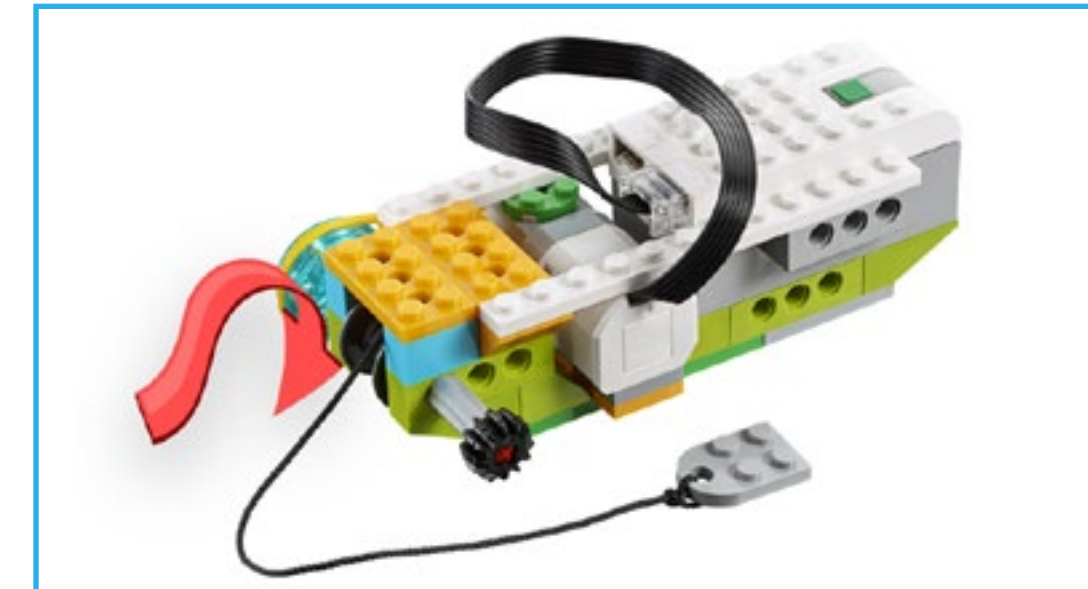
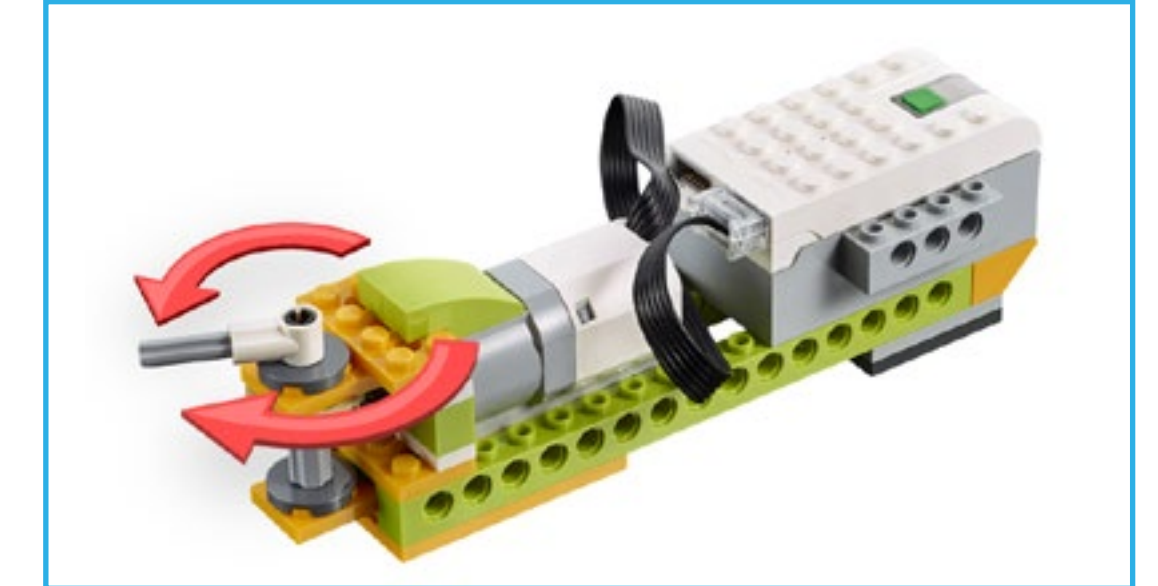

Share phase

Students should present their models, explaining the representation of the effect the habitat has on the creature. They could use research and portfolio documentation to support their explorations and ideas.

Assessment

Ensure that students explain the adaptations and unique characteristics the creature needs to develop and survive.

Project 12

Space Exploration

This project is about designing a LEGO® prototype of a rover that would be ideal for exploring distant planets.



Curriculum link

NGSS

3-5-ETS1-2: Generate and compare multiple possible solutions to a problem based on how well each is likely to meet the criteria and constraints of the problem.

3-5-ETS1-3: Plan and carry out fair tests in which variables are controlled and failure points are considered to identify aspects of a model or prototype that can be improved.

Common Core State Standards for English Language Arts

CCSS.ELA-Literacy.SL.3.1.D: Explain their own ideas and comprehension in light of the discussion.

CCSS.ELA-Literacy.W.3.1.B: Provide reasons that support the opinion.

CCSS.ELA-Literacy.SL.4.4 and 5.4: Report on a topic or text, tell a story, or recount an experience in an organized manner, using appropriate facts and relevant, descriptive details to support main ideas or themes; speak clearly at an understandable pace.

Explore phase

A rover is an automated motor vehicle that propels itself across the surface of a celestial body. A rover may examine territory and interesting features, analyze weather conditions, or even test materials, such as soil and water.

Let students explore rovers and discover their many interesting features and functions. Students should design various functions for their rover prototype.

Create phase

Students design, build, and test a rover that can achieve one of the following missions when sent to another planet:

- Move in and out of a crater.
- Collect a rock sample.
- Drill a hole in the ground.

Let students explore the Design Library so they can choose a model for inspiration. Then allow them to experiment and create their own solutions, modifying any basic model as they see fit.

Suggested Design Library models are:

- Drive
- Grab
- Sweep

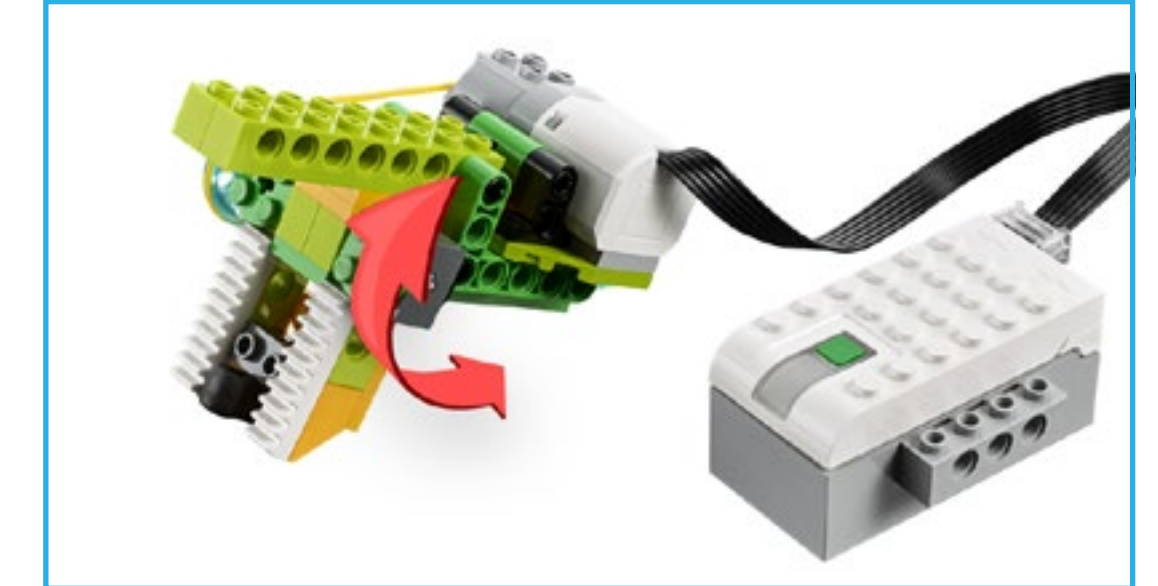

Share phase

Students should present their models, explaining how they have designed and tested their rover to complete a series of planet exploration-based tasks. Have students compare models and provide feedback to each other on how well the models fit the constraints and meet the criteria of the given problem.

Assessment

Ensure that students explain why each function is important and how they have allowed for the rover to move over fluctuating terrain to complete the assigned/ chosen task.

Project 13

Hazard Alarm

This project is about designing a LEGO® prototype of a weather alarm device to alert people and reduce the impact of strong storms.





Curriculum link

NGSS

3-5-ETS1-2: Generate and compare multiple possible solutions to a problem based on how well each is likely to meet the criteria and constraints of the problem.

3-5-ESS3-1: Make a claim about the merit of a design solution that reduces the impact of a weather-related hazard.

Common Core State Standards for English Language Arts

CCSS.ELA-Literacy.SL.3.1.D: Explain their own ideas and comprehension in light of the discussion.

CCSS.ELA-Literacy.W.3.1.B: Provide reasons that support the opinion.

CCSS.ELA-Literacy.SL.4.4 and 5.4: Report on a topic or text, tell a story, or recount an experience in an organized manner, using appropriate facts and relevant, descriptive details to support main ideas or themes; speak clearly at an understandable pace.

Explore phase

The National Oceanic and Atmospheric Administration's (NOAA) Storm Prediction Center (SPC) exists to protect people by issuing timely and accurate forecasts for tornadoes, wildfires, and other hazards. Early warning systems for such storms help save buildings, property, and lives.

Let students explore the equipment and alarm systems.



Create phase

Students design, build, and test an alarm device for wind, rain, fire, earthquake, or other weather-related hazards. This could be done according to a set of criteria or with a more open outcome as determined by the teacher.

Let students explore the Design Library so they can choose a model for inspiration. Then allow them to experiment and create their own solutions, modifying any basic model as they see fit.

Suggested Design Library models are:

- Spin
- Revolve
- Motion

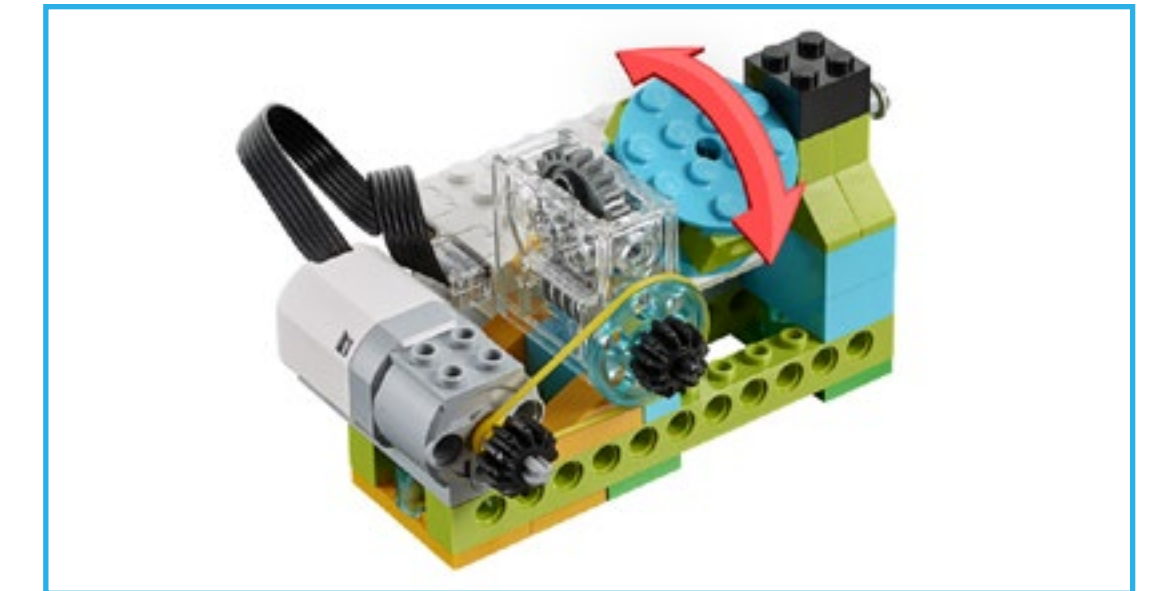
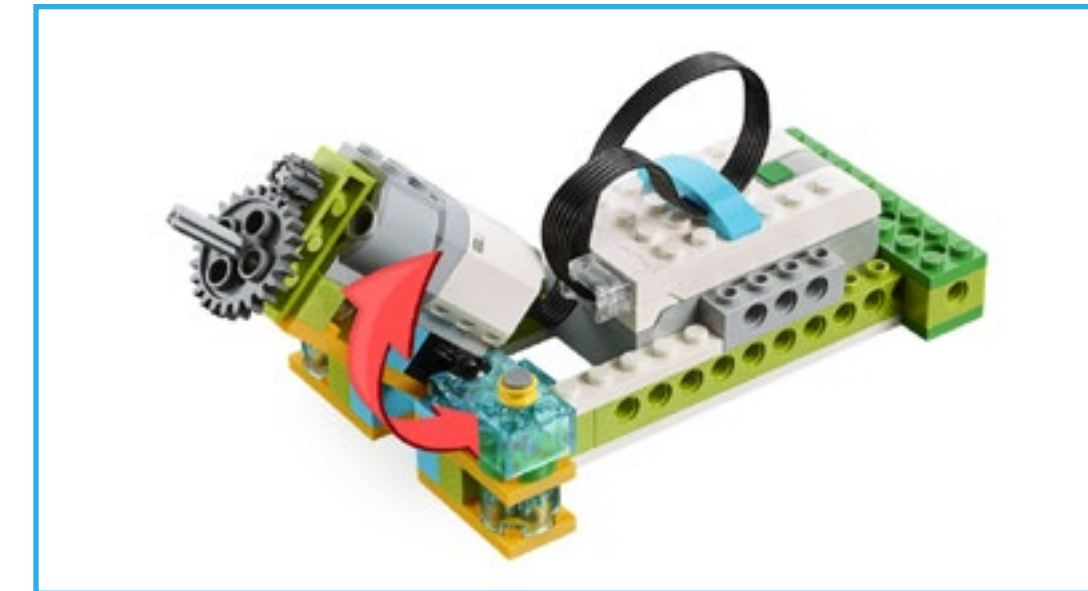

Share phase

Students should present their models, explaining how they designed and tested the hazard alarms. They could use research and portfolio documentation to support their explorations and ideas.

Assessment

Ensure that students explain why the alarm is important and how it has been designed and tested to help reduce the impact of the specific hazard or alert people to potential hazards.

Project 14

Cleaning the Ocean

This project is about designing a LEGO® prototype for a device that could help remove plastic waste from the ocean.





Curriculum link

NGSS

3-5-ETS1-1. Define a simple design problem reflecting a need or a want that includes specified criteria for success and constraints on materials, time, or cost.

3-5-ETS1-2: Generate and compare multiple possible solutions to a problem based on how well each is likely to meet the criteria and constraints of the problem.

Common Core State Standards for English Language Arts

CCSS.ELA-Literacy.SL.3.1.D: Explain their own ideas and comprehension in light of the discussion.

CCSS.ELA-Literacy.W.3.1.B: Provide reasons that support the opinion.

Explore phase

Millions of tons of plastic have entered the oceans in recent decades. It is important that the oceans are cleared of plastic bags, bottles, containers, and other debris that are endangering sea animals and fish and their habitats.

Let students explore collection technology and vehicles currently used and being proposed to clean the oceans of plastic waste.



Create phase

Students design and build a plastic waste collection vehicle or device. Although a prototype, the model should ideally be able to physically collect plastics of a certain type.

Let students explore the Design Library so they can choose a model for inspiration. Then allow them to experiment and create their own solutions, modifying any basic model as they see fit.

Suggested Design Library models are:

- Reel
- Sweep
- Grab

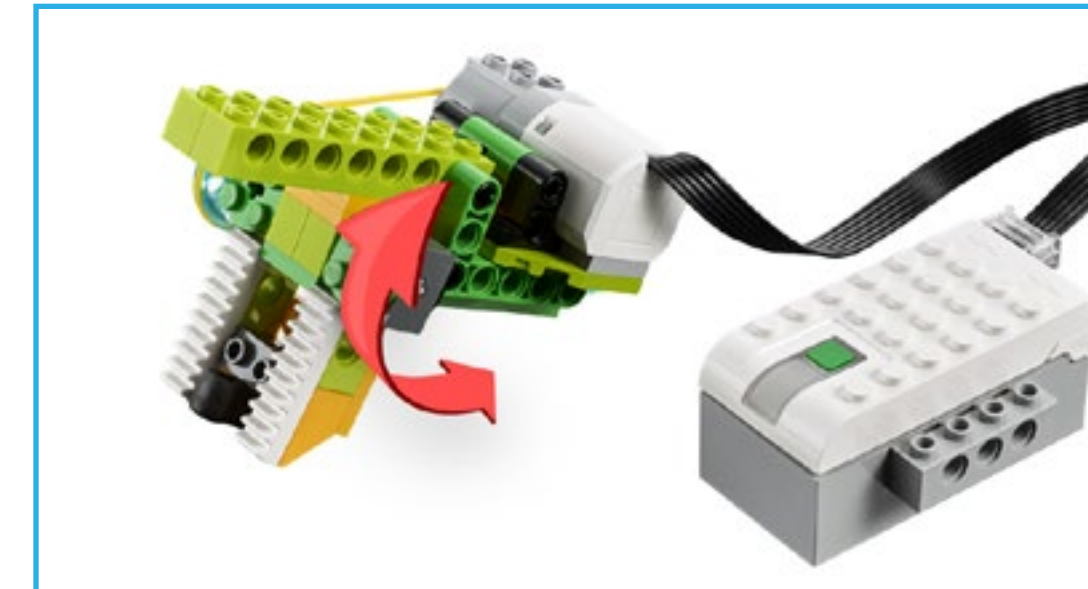
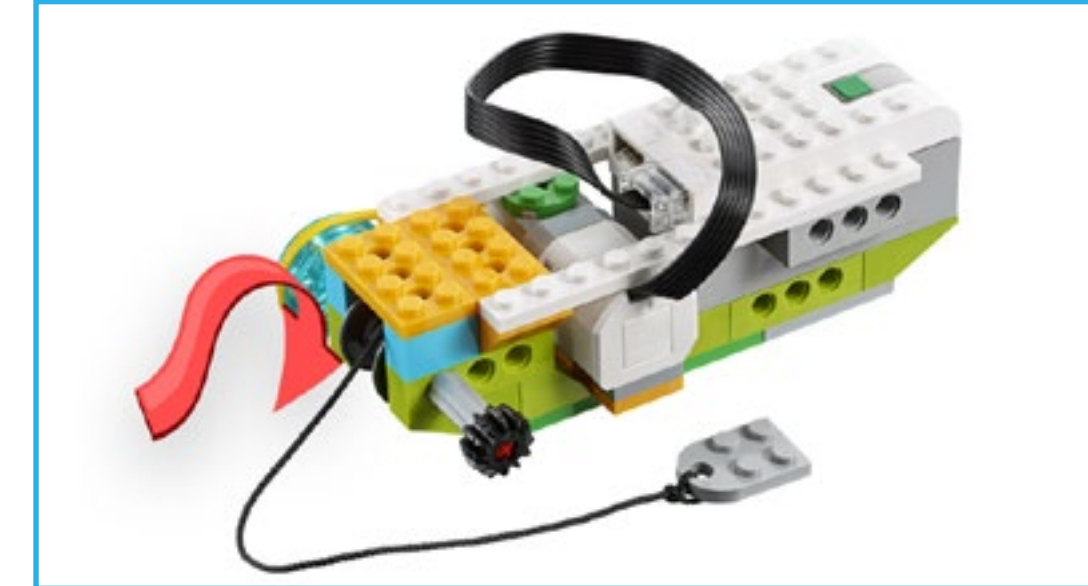

Share phase

Students should present their models, explaining how they have designed the prototype to collect plastics of a certain type. They could use research and portfolio documentation to support their explorations and ideas.

Assessment

Ensure that students explain why cleaning the ocean is important, and how their prototype provides an ideal solution to the problem.

Project 15

Wildlife Crossing

This project is about designing a LEGO® prototype to allow an endangered animal species to safely cross a road or other hazardous area.





Curriculum link

NGSS

3-LS4-4: Make a claim about the merit of a solution to a problem caused when the environment changes and the types of plants and animals that live there may change.

K-2-ETS1-1: Ask questions, make observations, and gather information about a situation people want to change to define a simple problem that can be solved through the development of a new or improved object or tool.

K-2-ETS1-3: Analyze data from tests of two objects designed to solve the same problem to compare the strengths and weaknesses of how each performs.

2-LS4-1: Make observations of plants and animals to compare the diversity of life in different habitats.

Common Core State Standards for English Language Arts

CCSS.ELA-Literacy.RI.2.3: Describe the connection among a series of historical events, scientific ideas or concepts, or steps in technical procedures in a text.

CCSS.ELA-Literacy.W.2.7: Participate in shared research and writing projects (e.g., read a number of books on a single topic to produce a report; record scientific observations).

Crosscutting concepts

Systems and systems models

Explore phase

Wildlife crossings are structures that allow animals to cross human-made barriers safely. Wildlife crossings include underpasses, tunnels, and viaducts. Rescue vehicles are also used in extreme or difficult cases.

Let students explore existing wildlife crossings, especially local examples, such as underpasses and cattle crossings. You may also wish to share specific examples of situations or conditions in which wildlife is put at risk and a crossing may be a solution.



Create phase

Students design and build a wildlife crossing for a chosen animal. They could also build the road or hazard that the safe crossing is designed to avoid.

Let students explore the Design Library so they can choose a model for inspiration. Then allow them to experiment and create their own solutions, modifying any basic model as they see fit.

Suggested Design Library models are:

- Spin
- Revolve
- Flex

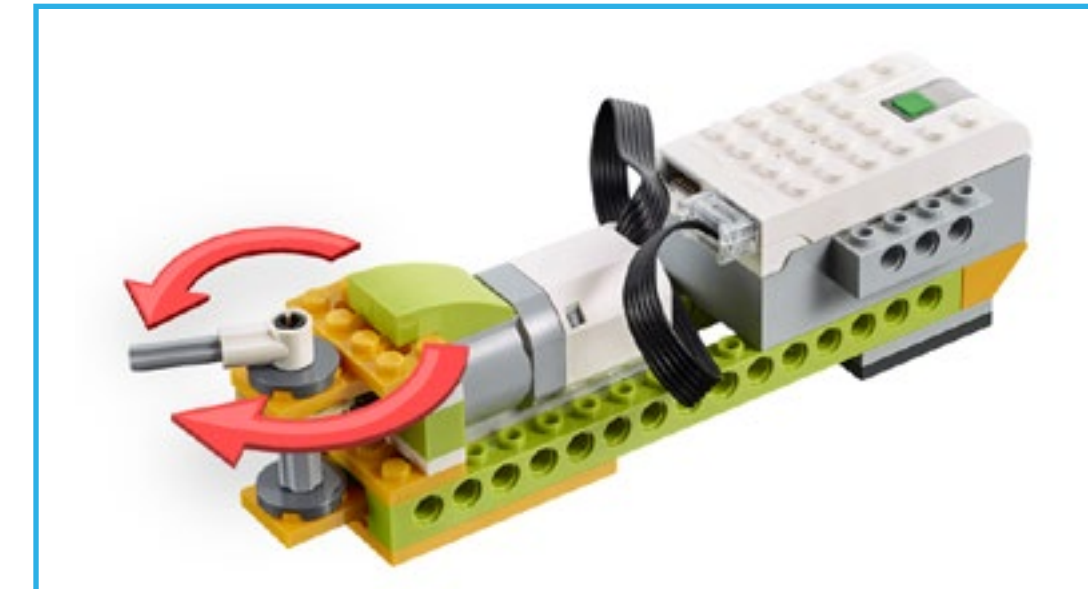
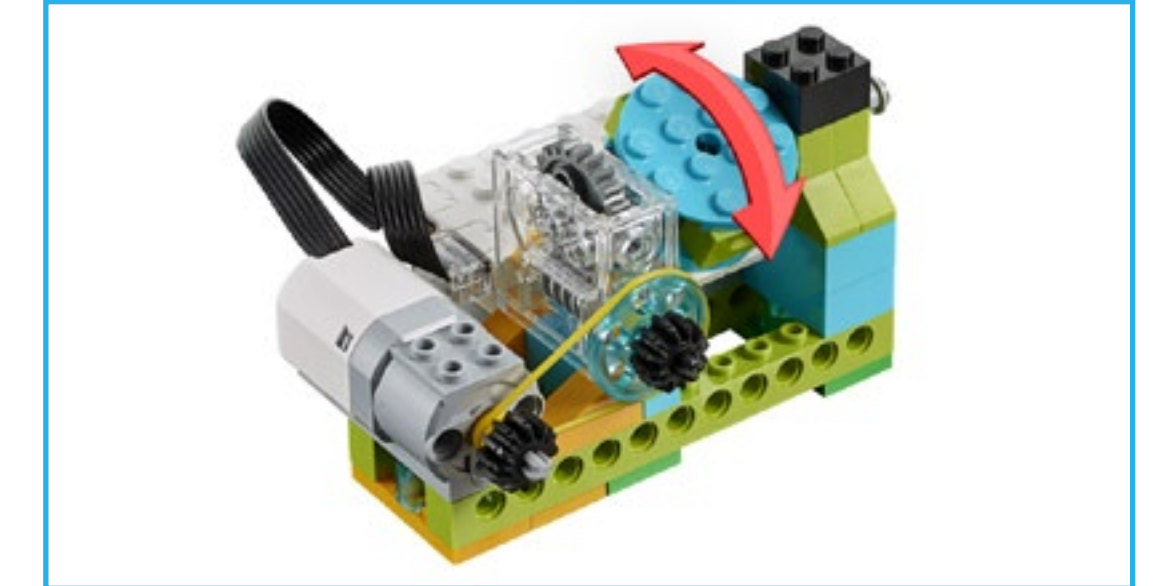
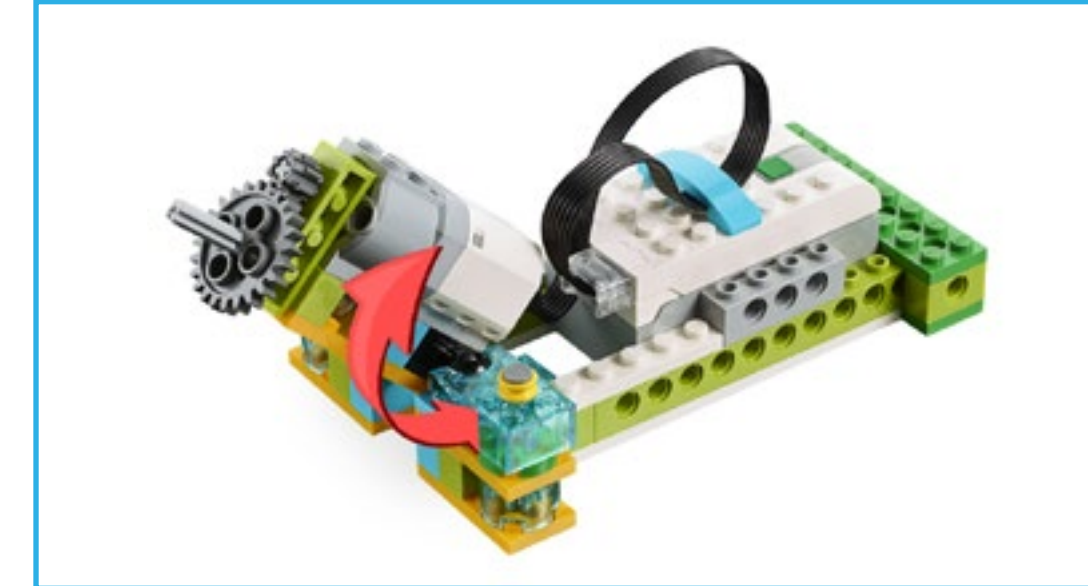

Share phase

Students should present their models, explaining how they have designed the prototype to allow for the chosen wildlife to cross safely. They could use research and portfolio documentation to support their explorations and ideas.

Assessment

Ensure that students explain why it is important to look after endangered species and be conscious of the impacts humans have on animal habitats.

Project 16

Moving Materials

This project is about designing a LEGO® prototype of a device that can move certain objects around in a very safe and efficient way.





Curriculum link

NGSS

2-PS1-3: Make observations to construct an evidence-based account of how an object made of a small set of pieces can be disassembled and made into a new object.

K-2-ETS1-2: Develop a simple sketch, drawing, or physical model to illustrate how the shape of an object helps it function as needed to solve a given problem.

Common Core State Standards for English Language Arts

CCSS.ELA-Literacy.RI.2.3: Describe the connection among a series of historical events, scientific ideas or concepts, or steps in technical procedures in a text.

CCSS.ELA-Literacy.W.2.7: Participate in shared research and writing projects (e.g., read a number of books on a single topic to produce a report; record scientific observations).

Crosscutting concepts

Energy and matter

Explore phase

The motorized forklift truck is used to lift and move heavy materials over short distances. It was developed in the early 20th century, but its use became widespread after World War II. Forklifts have become a vital part of warehouse and manufacturing operations.

Let students explore forklift truck designs and other ways to move objects, and make observations about the way these devices lift and move materials.

▶ Important

The focus of this project could be on both the device used to move the objects and on the way the objects are prepared to be moved, such as stacking them on pallets or in containers.



Create phase

Students design and build a vehicle or a device for lifting, moving, and/or packing a pre-determined set of objects. They should also consider how boxes can be designed to be moved and stored easily.

Let students explore the Design Library so they can choose a model for inspiration. Then allow them to experiment and create their own solutions, modifying any basic model as they see fit.

Suggested Design Library models are:

- Steer
- Grab
- Motion

Share phase

Students should present their models, explaining how the vehicle was designed to move objects. They could use research and portfolio documentation to support their explorations and ideas.

Assessment

Ensure that students explain how boxes can be designed to be moved and stored easily and how the design allows vehicles to do this efficiently.

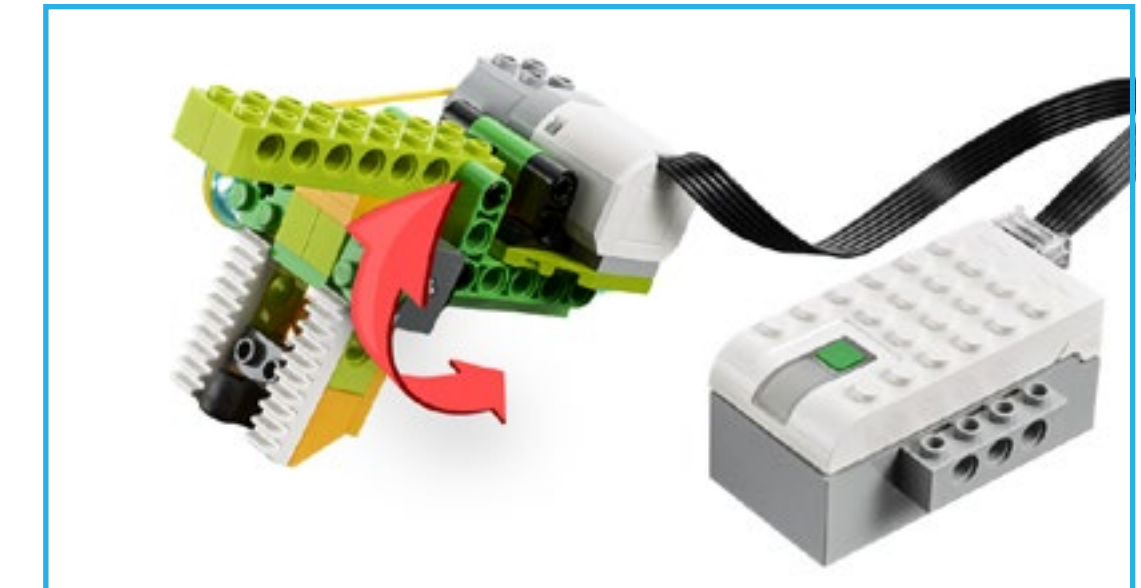

LEGO® Education WeDo 2.0 Toolbox

Program with WeDo 2.0
183-190

Build with WeDo 2.0
191-205



Program with WeDo 2.0

Programming is an important part of 21st century learning, and it is an essential part of all WeDo 2.0 projects.

It puts life into the models students have created and teaches them computational thinking.





Introduction to a WeDo 2.0 program string

When students want to give life to their models, they will drag and drop blocks on Programming Canvas. Your students will be creating program strings. They can create multiple program strings on the canvas, but each of these need to start with a Start Block.

Here are some important terms to use:

1. Start Block
A Start Block is required to execute a program string.
Execute means to start a series of actions until they are completed.
2. Programming block
Programming blocks are used in WeDo 2.0 Software to build a program string.
Blocks with symbols are used instead of text code.
3. Program string
A program string is a sequence of programming blocks.

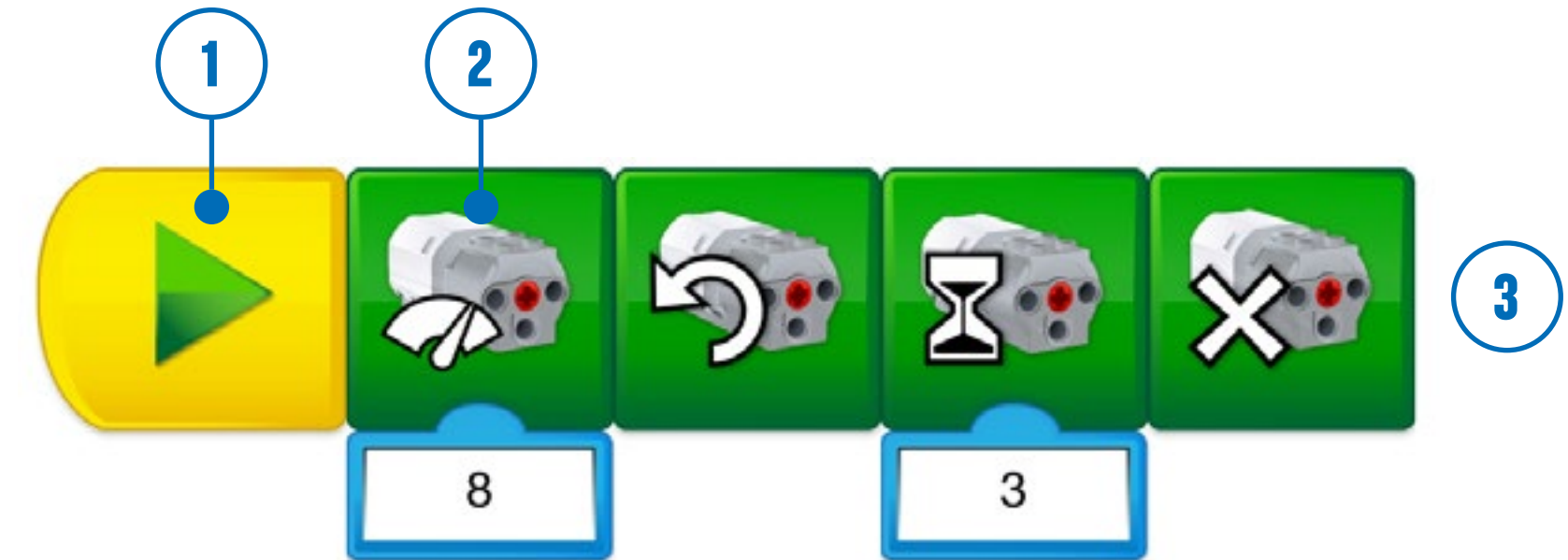



Top five program strings

The following program strings represent the most important functions with the WeDo 2.0 program string. It is recommended that you and your students are familiar with them.

▶ Important

In WeDo 2.0, the unit of time has been set to seconds. Students should therefore input:

- 1, for the motor to run for 1 sec.
- 4.5, for the motor to run for 4.5 sec.

Program string 1

Is my motor working?

This program is designed mainly to test the motor. When you Press Start, the power of the motor will be set to 10, and the motor will turn on in one direction for 3 sec., then in the other direction for 3 sec., and then stop.





Top five program strings

Program string 2

Is my sensor responding?

To be able to use this program, you need a motor and a Motion Sensor attached to the Smarthub. By executing the program, the motor will turn on in one direction and wait for an object (e.g., your hand) to pass in front of the Motion Sensor. When an object is detected, the motor will stop.

The same program can be used with the Tilt Sensor Input or the Sound Sensor Input by changing the attachment of the Wait For Block.



Program string 3

Is the light flashing?

This program is a simple test on the light of the Smarthub. By executing the program, the light will light up for 1 sec. and turn off for 1 sec. These actions will be repeated infinitely, making the light on the Smarthub flash.





Top five program strings

Program string 4

Is my device making sounds?

This program will play sound no. 1 from your device.



Program string 5

Is my device displaying images?

This program will show image no. 1 as well as the word "WeDo" on the display.





Other programming opportunities

The following are other frequently occurring programs.

Once the top five program strings have been explored, it is recommended that the teacher and students become familiar with their functions.

Program string 6

Using the Random Input

This program string will change the color of the light on the Smarthub randomly, changing the color every second.





Other programming opportunities

Program string 7

Activating two motors at the same time

You can label Motor Blocks and Sensor Inputs if you are using more than one at a time. You can use a maximum of three LEGO® Smarthubs at the same time.

To label a Block or an Input, Long Press the block you need to label to open the labeling panel:

- Press once to label with one dot.
- Press again to label from two to six dots.
- Press again to remove the label.

If a Motor Block is not labeled and more than one motor is connected, all motors will be executed the same way. If a Sensor Input block is not labeled and more than one sensor is connected, it waits for one of the connected sensors.



Program string 8

Use the Sound Sensor Input

This program string will rotate the motor with a power level matching the level of sound detected by the microphone of your device:

- If the sound level is low, the motor will rotate slowly.
- If the sound level is high, the motor will rotate rapidly.





Other programming opportunities

Program string 9

Create a countdown

This program string will display numbers on the screen, starting from five, and count down every second. When the loop has run five times, a sound will be played.



Program string 10

Do two things at the same time

When the Play icon is tapped, it will send a message no. 1 (WeDo) to the programming canvas. All the "play on" message blocks that have message no. 1 (WeDo) will then be triggered, playing, in this case, a sound and displaying an image at the same time.



Build with WeDo 2.0

WeDo 2.0 has been designed to provide opportunities for students to sketch, build, and test prototypes and representations of objects, animals, and vehicles that have a real-world focus.

The hands-on approach encourages students to be fully engaged in the designing and building process.





The importance of designing in WeDo 2.0

The WeDo 2.0 projects will take you and your students on a journey of using mechanisms in their models. These mechanism will bring their models to life.

These mechanisms have been ordered by function in the Design Library. In the software, students will find building instructions for something that:

1. Wobbles
2. Drives
3. Cranks
4. Walks
5. Spins
6. Flexes
7. Reels
8. Lifts
9. Grabs
10. Pushes
11. Revolves
12. Steers
13. Sweeps
14. Detects motion
15. Detects tilt

These are provided to give inspiration to your students when they look for solutions. All these functions use what is called “simple machines” that you could explore with your students at the same time.





Base models exploration

Name of the part: Gear

A gear is a toothed wheel that rotates and makes another part move. You can find gear wheels on your bike, as they are linked together with a chain. A gear train is when gears are placed directly alongside each other.

Types of gear train

Gear up: A large gear drives a small gear to produce more rotations.

Gear down: A small gear drives a large gear to produce fewer rotations.

Used in Design Library base models

Walk, Spin



Name of the part: Bevel gear

This part is an angled gear, as it can be placed perpendicular to another gear, changing the axis of rotation.

Used in Design Library base models

Flex, Wobble, Push

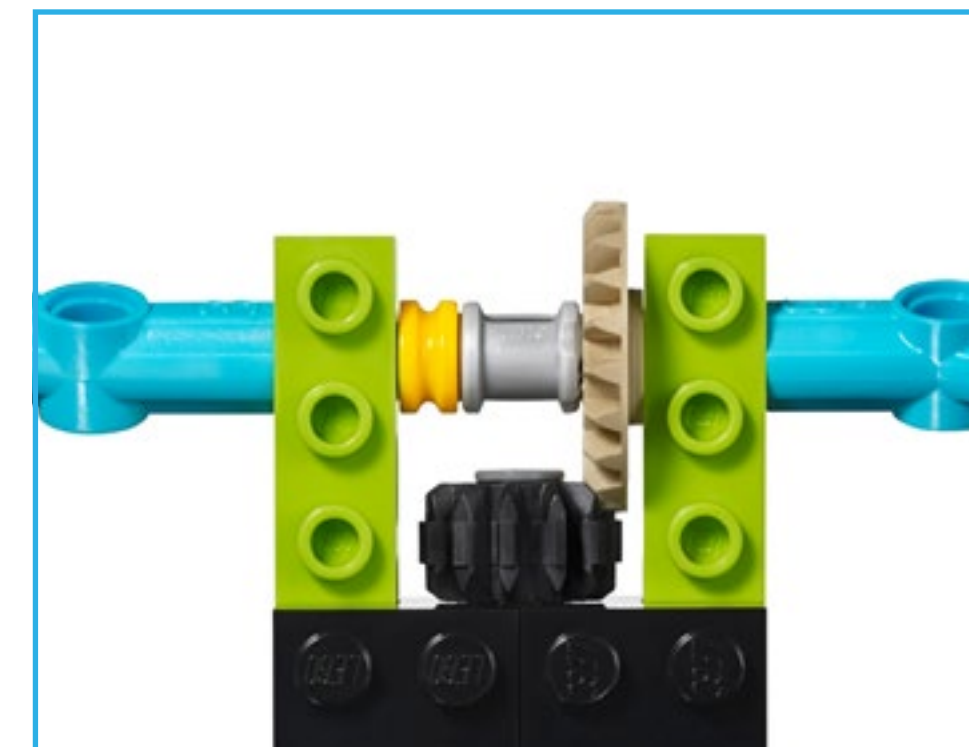



Base models exploration

Name of the part: Rack

A rack is a flat element with teeth that engages a circular gear, in this case often called a pinion. This pair of gears change ordinary rotational motion, as the gear turns into linear motion.

Used in Design Library base models

Push



Name of the part: Worm gear

A worm is a continual spiral groove like a screw, which meshes with a gear. The worm is designed to turn a normal gear, but the gear cannot turn the worm, therefore, it functions as a brake.

Used in Design Library base models

Revolve





Base models exploration

Name of part: Beam

A beam attached to a rotating part will become a piston. A piston is a moving component of a machine, transferring the energy created by the motor into an up/down or forward/backward motion. The piston can push, pull, or drive other mechanical elements of the same machine.

Used in Design Library base models

Crank

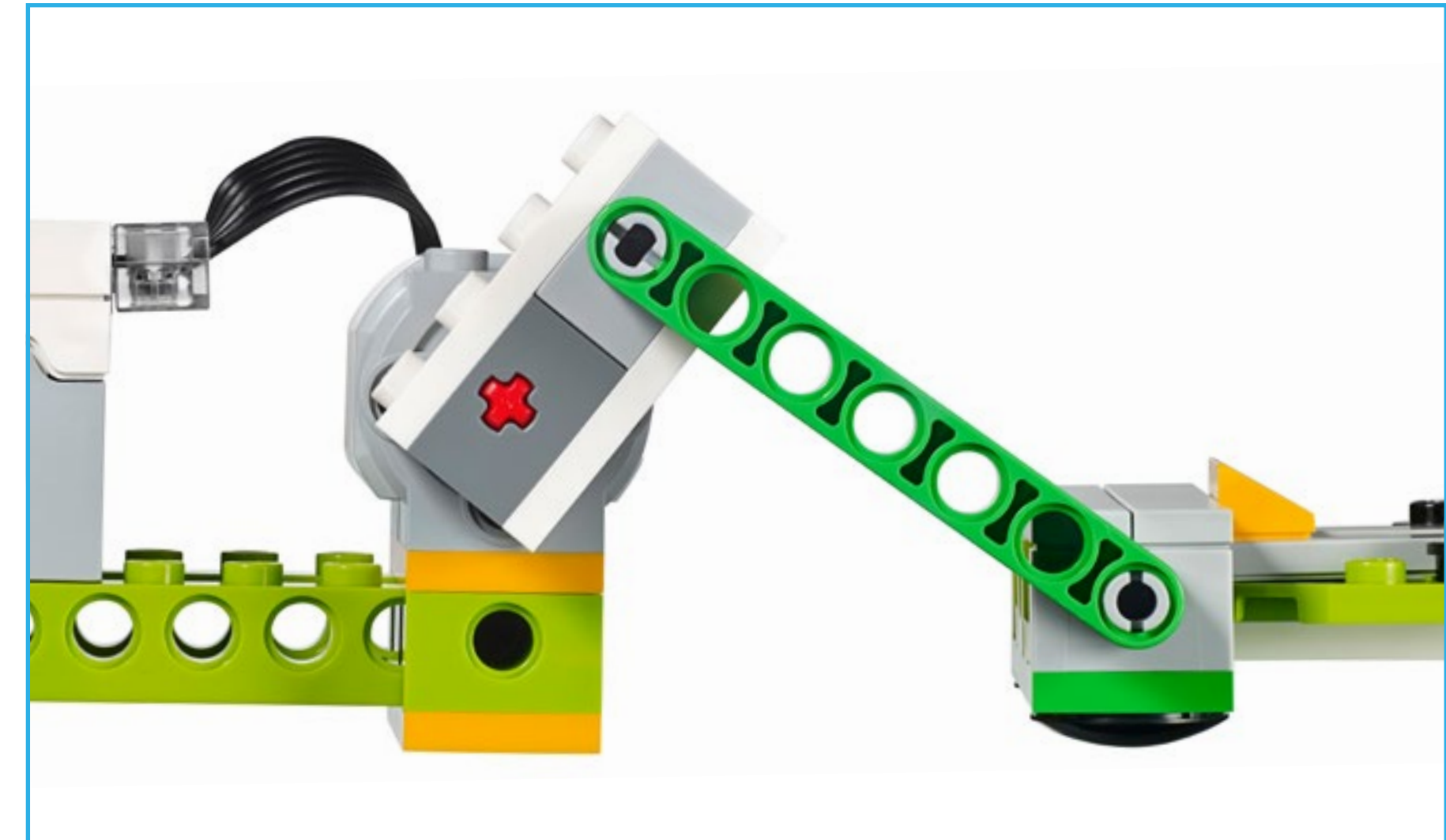

Name of the part: Wheels

It's a circular element that rotates on an axis to produce propelled movement.

Used in Design Library base models

Wobble, Drive, Steer





Base models exploration

Name of the part: Pulley

The pulley is a wheel with a groove in it where the belt rests. The belt is like a small rubber band, which connects to a part of the model that is rotating, transferring the rotation to a different part of the model.

Pulley up: A large pulley drives a small pulley to produce more rotations.

Pulley down: A small pulley drives a large pulley to produce less rotations.

Pulley twist: It is used to make shafts that are parallel but rotate in opposite directions.

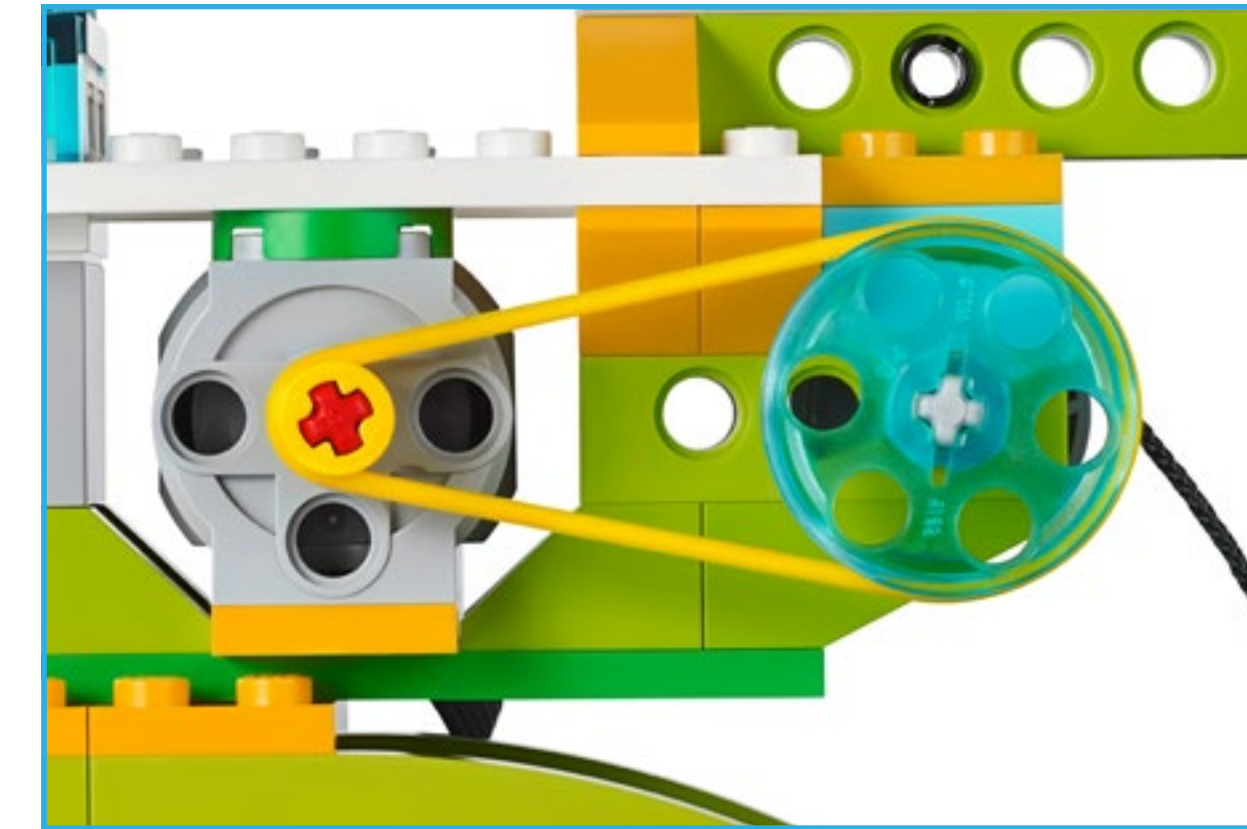

Used in Design Library base models

Reel, Lift, Drive, Sweep, Revolve, Grab

▶ Important

Using a pulley in a mechanism will prevent the model from breaking when it meets resistance as the belt will slip in the pulley.

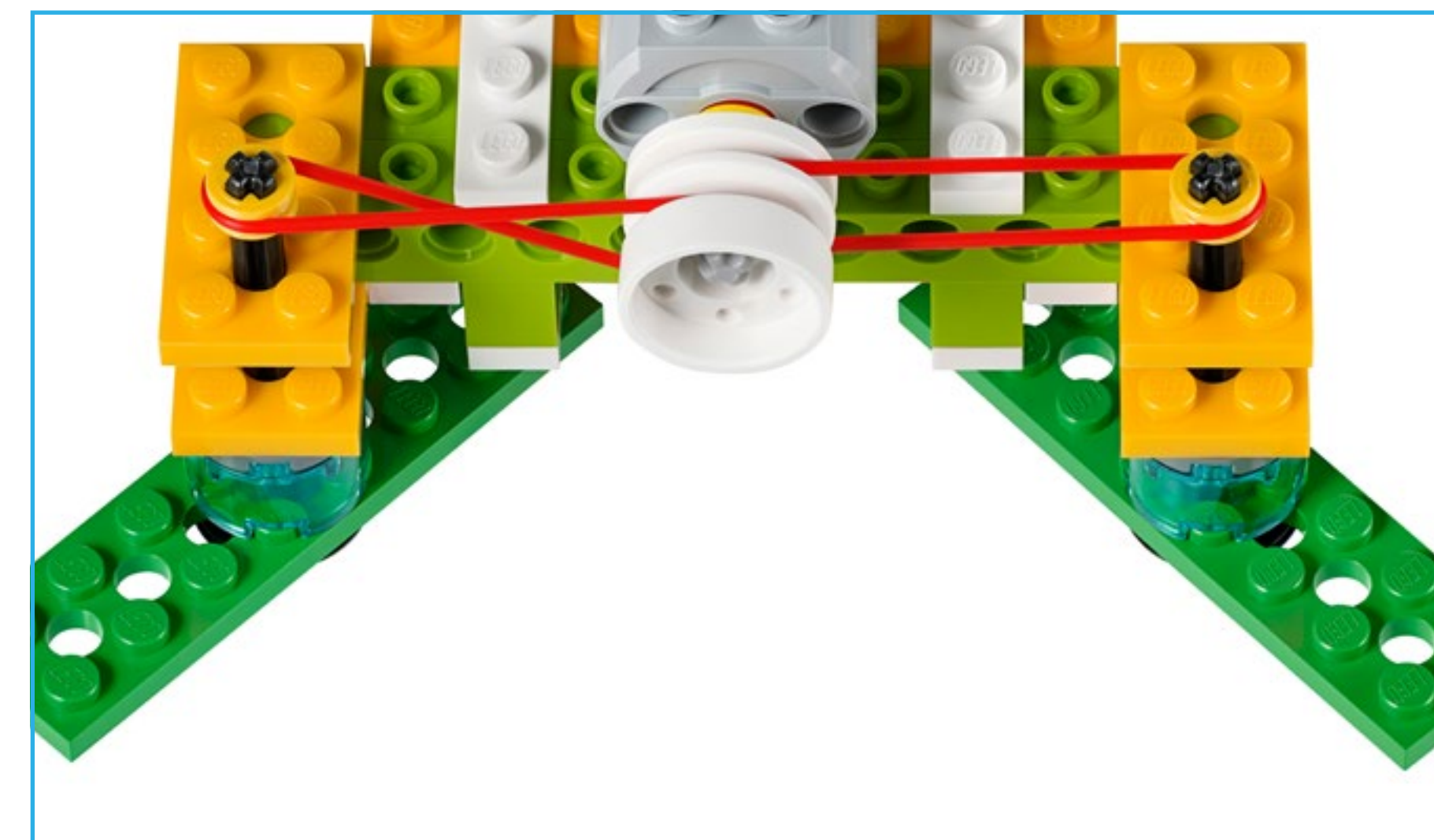



Electronic parts

Smarthub

The Smarthub acts as a wireless connector among your device and the other electronic parts, using Bluetooth Low Energy. It receives program strings from the device and executes them.

The Smarthub has important features:

- Two ports to connect sensors or motors
- One light
- Power button

The Smarthub uses AA batteries or the supplementary Rechargeable Battery as a power source.

The Bluetooth connection procedure between the Smarthub and your device is explained in the WeDo 2.0 Software.

The Smarthub will use color patterns to signal messages:

- Flashing white light: It is waiting for a Bluetooth connection.
- Blue light: A Bluetooth connection is established.
- Flashing orange light: The power provided to the motor is at its limit.





Electronic parts

Smarthub Rechargeable Battery (supplementary item)

Here are some guidelines for the Smarthub Rechargeable Battery:

- To have optimal hours of play without the adaptor connected, fully charge the battery first.
- There is no special demand for a charging pattern.
- Preferably, store the battery in a cool place.
- If the battery is installed in the Smarthub and not used from one to two months, recharge it again after this period.
- Do not let the battery charge for an extended period of time.



Medium Motor

A motor is what makes other things move. This Medium Motor uses electricity to make an axle rotate.

The motor can be started in both directions, can be stopped, and can turn at different speeds and for a specific amount of time (specified in seconds).





Electronic parts: sensors

Tilt Sensor

To interact with this sensor, tilt the part in different ways following the arrows.

This sensor detects changes within six different positions:

- Tilt this way
- Tilt that way
- Tilt up
- Tilt down
- No tilt
- Any tilt

Make sure you have the correct icon in your program that corresponds to the position you are trying to detect.



Motion Sensor

This sensor detects changes in distance from an object within its range in three different ways:

- Object moving closer
- Object moving farther away
- Object changing position

Make sure you have the correct icon in your program that corresponds to the position you are trying to detect.





Part names and primary functions

As students use the bricks, you may want to discuss proper vocabulary as well as functions for each part in the set.

- Some of them are structural parts that hold your model together.
- Some parts are connectors that link elements to each other.
- Some parts are used to produce movement.

▶ Important

Remember that these categories are guidelines. Some parts have many functions and can be used in many ways.

▶ Suggestion

Use the cardboard box to help you sort the parts in the WeDo 2.0 storage box. This will help you and your students view and count the parts.

©2016 The LEGO Group. 6145262

45300



Structural parts



2x - Angular plate, 1x2/2x2, white. No.6117940



4x - Roof brick, 1x2x2, gray. No.4515374



2x - Tile, 1x2, azure blue. No.4649741



4x - Roof brick, 1x2/45°, lime green. No.4537925



2x - Curved brick, 1x3, lime green. No.4537928



4x - Roof brick, 1x2x2/3, bright orange. No.6024286



6x - Plate, 1x2, white. No.302301

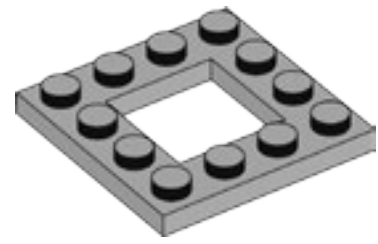

2x - Frame plate, 4x4, gray. No.4612621

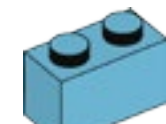

6x - Brick, 1x2, azure blue. No.6092674

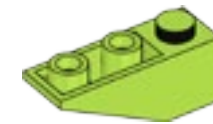

4x - Inverted roof brick, 1x3/25°, lime green. No.6138622

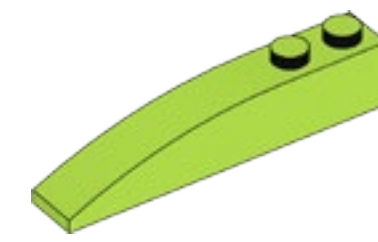

4x - Curved brick, 1x6, lime green. No.6139693



4x - Inverted roof brick, 1x2/45°, bright orange. No.6136455



4x - Plate, 1x4, white. No.371001

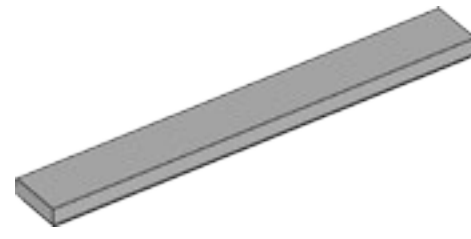

4x - Tile, 1x8, gray. No.4211481

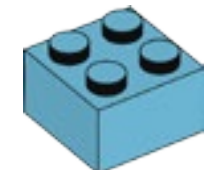

2x - Brick, 2x2, azure blue. No.4653970

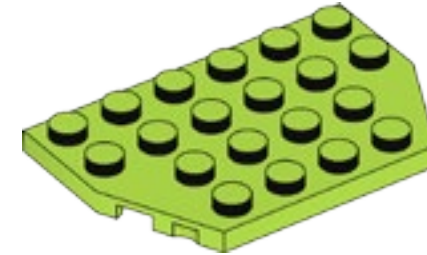

2x - Plate, 4x6/4, lime green. No.6116514

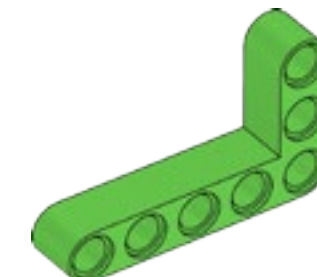

2x - Angular beam, 3x5-modules, bright green. No.6097397

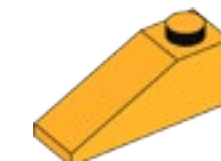

4x - Roof brick, 1x3/25°, bright orange. No.6131583

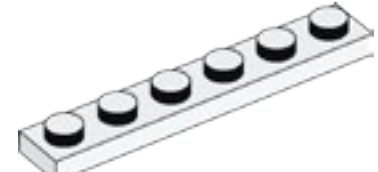

4x - Plate, 1x6, white. No.366601

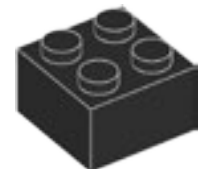

4x - Brick, 2x2, black. No.300326

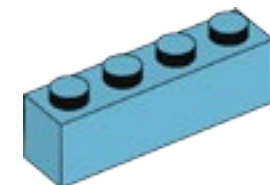

2x - Brick, 1x4, azure blue. No.6036238



4x - Studded beam, 1x2, lime green. No.6132372

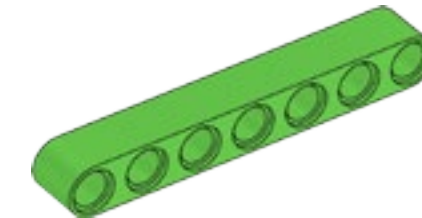

2x - Beam, 7-modules, bright green. No.6097392

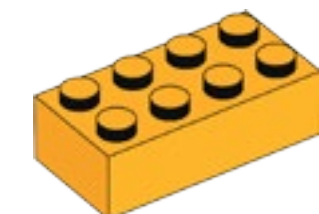

4x - Brick, 2x4, bright orange. No.6100027

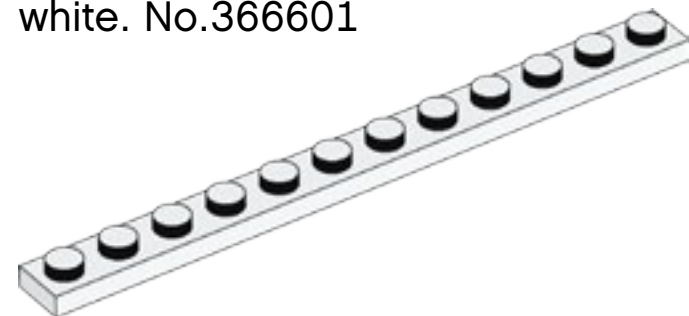

2x - Plate, 1x12, white. No.4514842

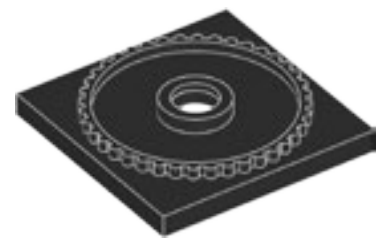

1x - Bottom for turntable, 4x4, black. No.4517986

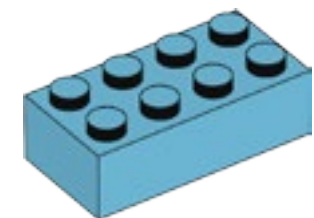

2x - Brick, 2x4, azure blue. No.4625629

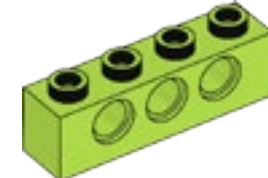

4x - Studded beam, 1x4, lime green. No.6132373

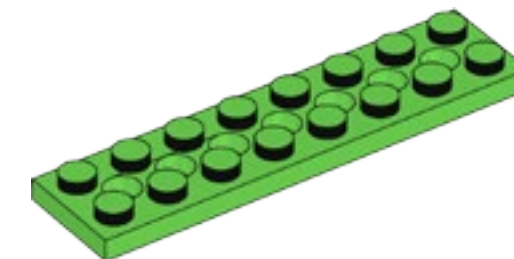

2x - Plate with holes, 2x8, bright green. No.6138494

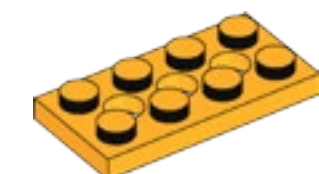

4x - Plate with holes, 2x4, bright orange. No.6132408



4x - Beam with plate, 2-modules, black. No.4144024



2x - Curved plate, 1x4x2/3, azure blue. No.6097093

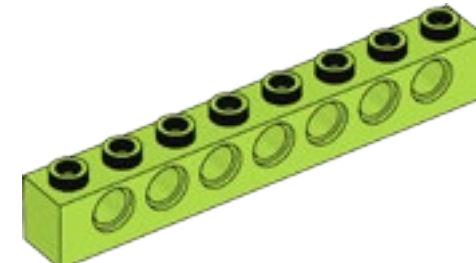

2x - Studded beam, 1x8, lime green. No.6132375

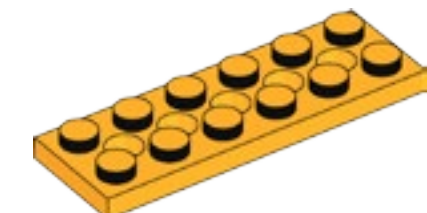

4x - Plate with holes, 2x6, bright orange. No.6132409



2x - Roof brick, 1x2/45°, black. No.4121966



2x - Round plate, 4x4, azure blue. No.6102828

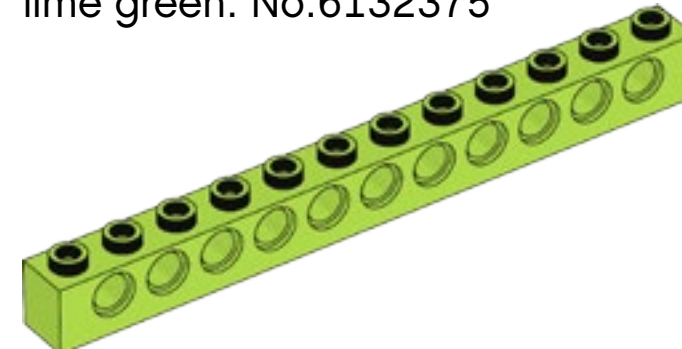

2x - Studded beam, 1x12, lime green. No.6132377

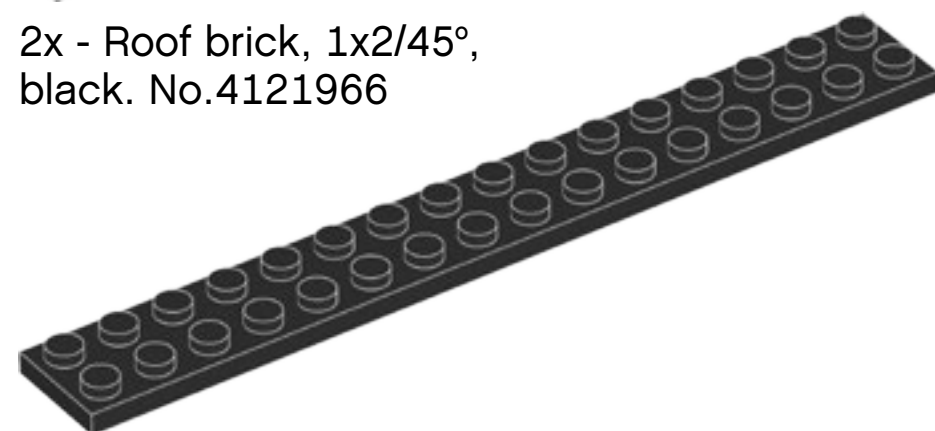

2x - Plate, 2x16, black. No.428226

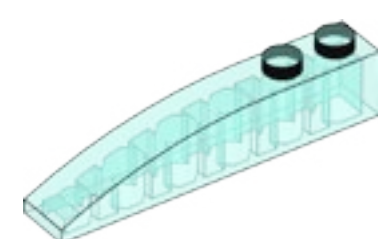

2x - Curved brick, 1x6, transparent light blue. No.6032418

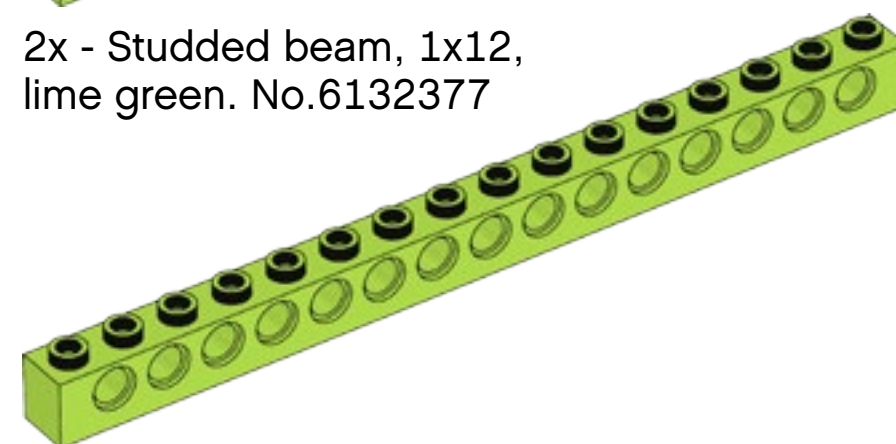

2x - Studded beam, 1x16, lime green. No.6132379

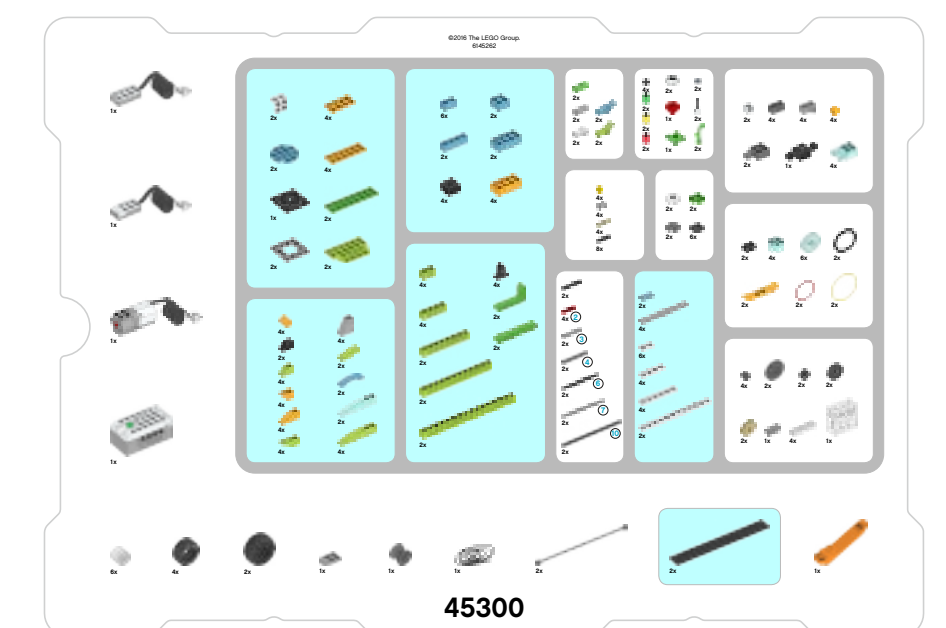



Connecting parts



2x - Brick with stud on side, 1x1, white. No.4558952



4x - Bushing, 1-module, gray. No.4211622



8x - Connector peg, with friction, 2-modules, black. No.4121715

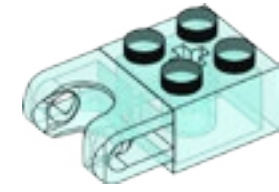

4x - Brick with ball bearing, 2x2, transparent light blue. No.6045980



2x - Angular block 4, 135°, lime green. No.6097773



4x - Connector peg, without friction/axle, 1-module/1-module, beige. No.4666579



2x - Angular block 1, 0°, white. No.4118981



2x - Bushing/axle extender, 2-module, gray. No.4512360



1x - Brick with 2 ball joints, 2x2, black. No.6092732



2x - Angular block 3, 157,5°, azure blue. No.6133917



2x - Tube, 2-modules, bright green. No.6097400



4x - Ball with crosshole, bright orange. No.6071608

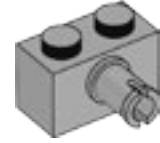

4x - Brick with connector peg, 1x2, gray. No.4211364



1x - String, 50 cm, black. No.6123991



4x - Bushing/pulley, 1/2-module, yellow. No.4239601



1x - Plate with hole, 2x3, gray. No.4211419



4x - Studded beam with crosshole, 1x2, dark gray. No.4210935

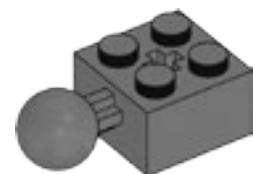

2x - Brick with 1 ball joint, 2x2, dark gray. No.4497253



1x - Bobbin, dark gray. No.4239891



2x - Chain, 16-modules, dark gray. No.4516456

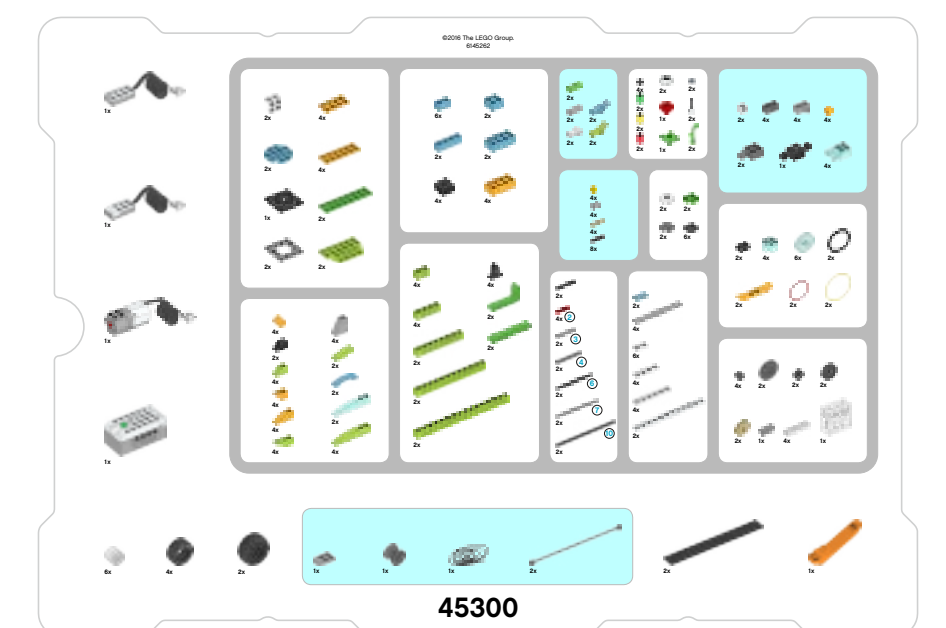



Movement parts



6x - Hub/pulley, 18x14 mm, white. No.6092256

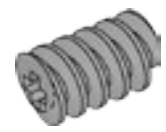

1x - Worm gear, gray. No.4211510



2x - Rubber beam with crossholes, 2-modules, black. No.4198367



4x - Axle, 2-modules, red. No.4142865



2x - Bevel gear, 20-tooth, beige. No.6031962

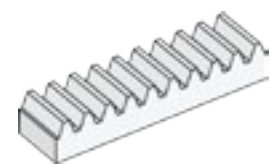

4x - Gear rack, 10-tooth, white. No.4250465



4x - Gear, 8-tooth, dark gray. No.6012451



2x - Double bevel gear, 12-tooth, black. No.4177431



2x - Connector peg with axle, 3-modules, black. No.6089119



2x - Belt, 33 mm, yellow. No.4544151

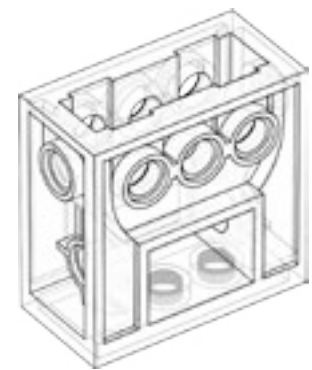

1x - Gear block, transparent. No.4142824



2x - Gear, 24-tooth, dark gray. No.6133119



2x - Double bevel gear, 20-tooth, black. No.6093977



2x - Axle, 3-modules, gray. No.4211815



2x - Snowboard, bright orange. No.6105957



2x - Tire, 30.4x4 mm, black. No.6028041



2x - Axle with stop, 4-modules, dark gray. No.6083620



2x - Belt, 24 mm, red. No.4544143



4x - Round brick, 2x2, transparent light blue. No.4178398



4x - Tire, 30.4x14 mm, black. No.4619323

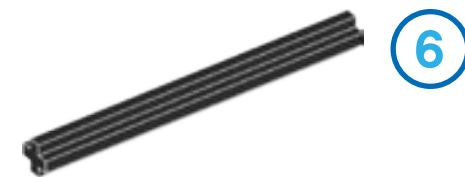

2x - Axle, 6-modules, black. No.370626

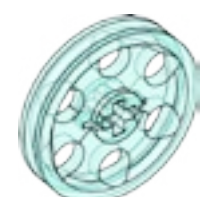

6x - Hub/pulley, 24x4 mm, transparent light blue. No.6096296



2x - Tire, 37x18 mm, black. No.4506553

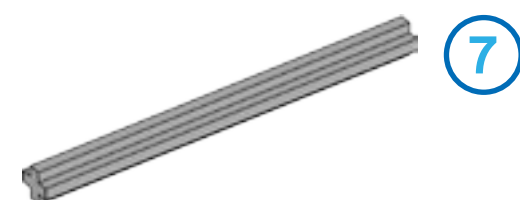

2x - Axle, 7-modules, gray. No.4211805

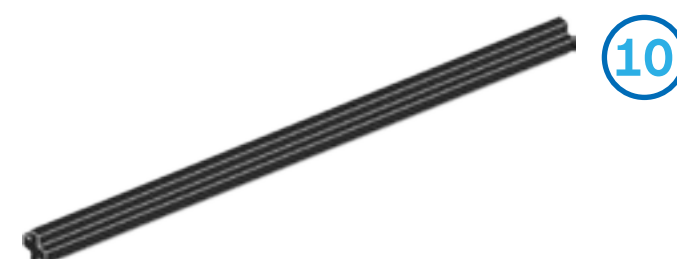

2x - Axle, 10-modules, black. No.373726

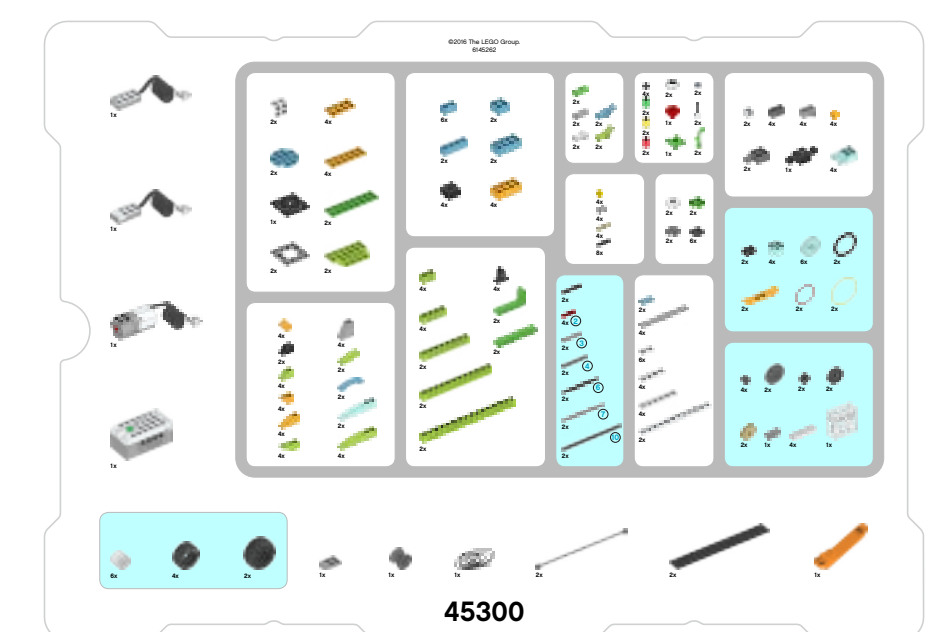



Decorative parts



2x - Antenna, white. No.73737



2x - Round brick, 1x1, transparent green. No.3006848



2x - Round brick, 1x1, transparent yellow. No.3006844



2x - Round tile with eye, 1x1, white. No.6029156



2x - Grass, 1x1, bright green. No.6050929



2x - Round brick, 1x1, transparent red. No.3006841



2x - Round tile with eye, 2x2, white. No.6060734



2x - Round plate, 2x2, bright green. No.6138624



1x - Flower, 2x2, red. No.6000020



2x - Round plate with 1 stud, 2x2, white. No.6093053



1x - Leaves, 2x2, bright green. No.4143562

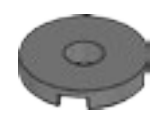

2x - Round tile with hole, 2x2, dark gray. No.6055313



4x - Round plate, 1x1, black. No.614126



6x - Skid plate, 2x2, black. No.4278359

Brick separator

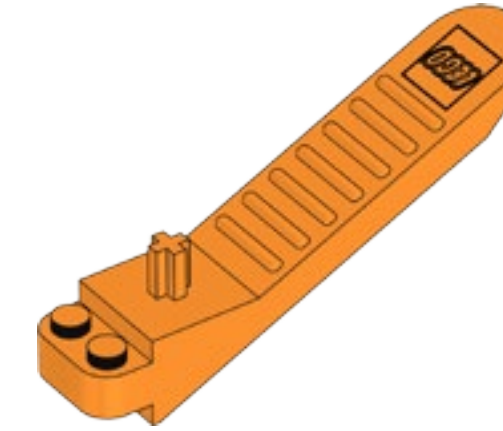

1x - Element separator, orange. No.4654448

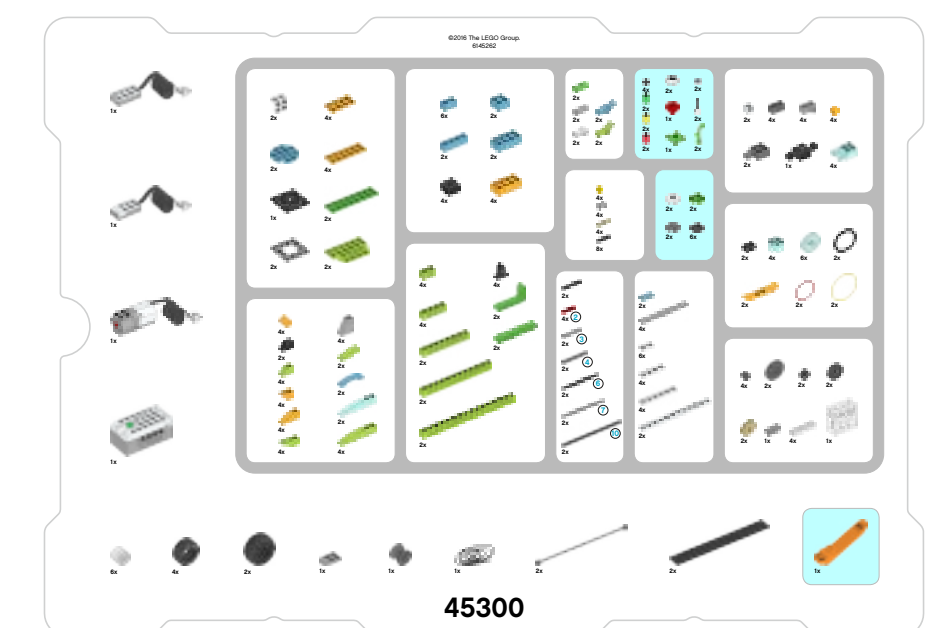



Electronic parts



1x - Tilt Sensor,
white. No.6109223

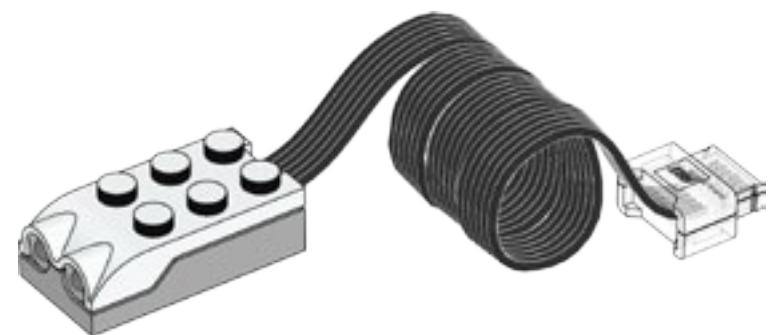

1x - Motion Sensor,
white. No.6109228

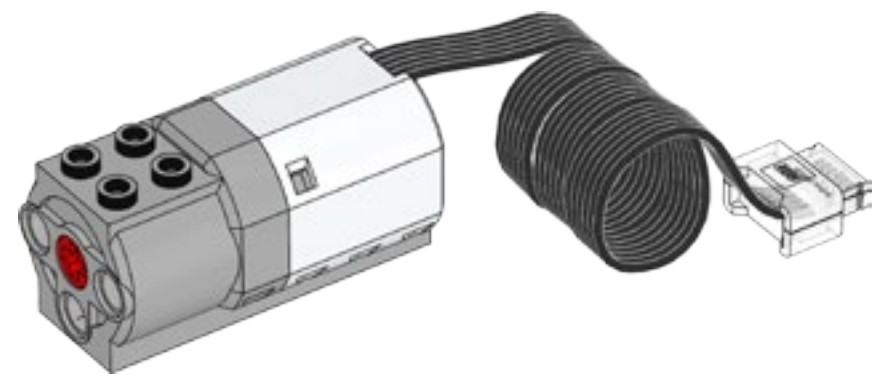

1x - Medium Motor,
white. No.6127110

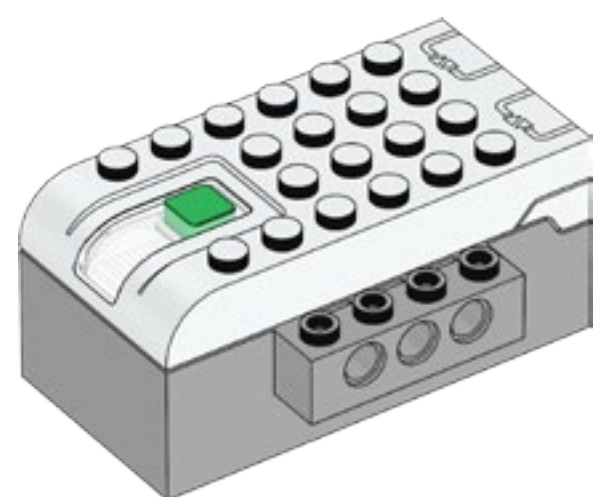

1x - Smarthub,
white. No.6096146

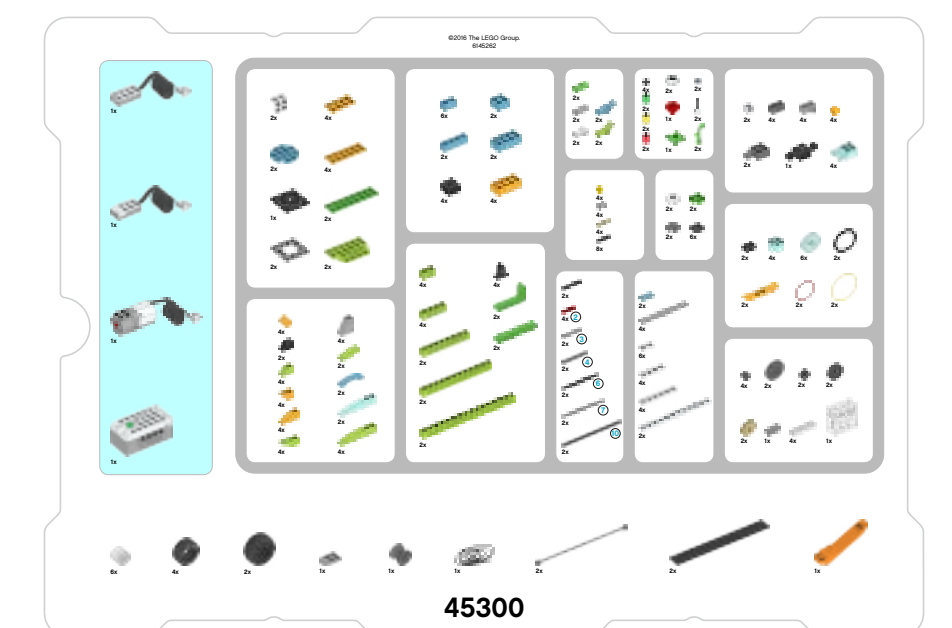

LEGO® Education WeDo 2.0

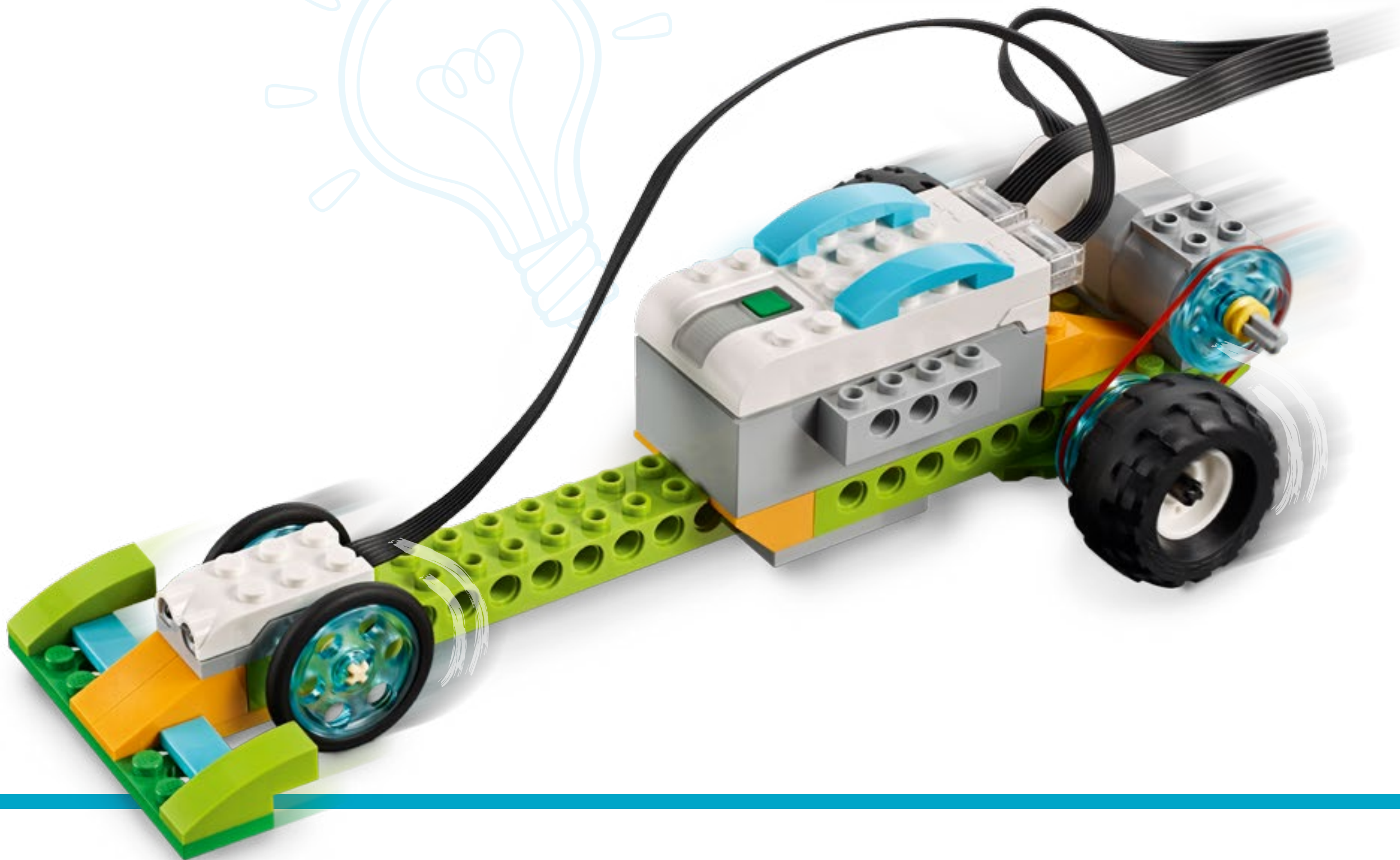
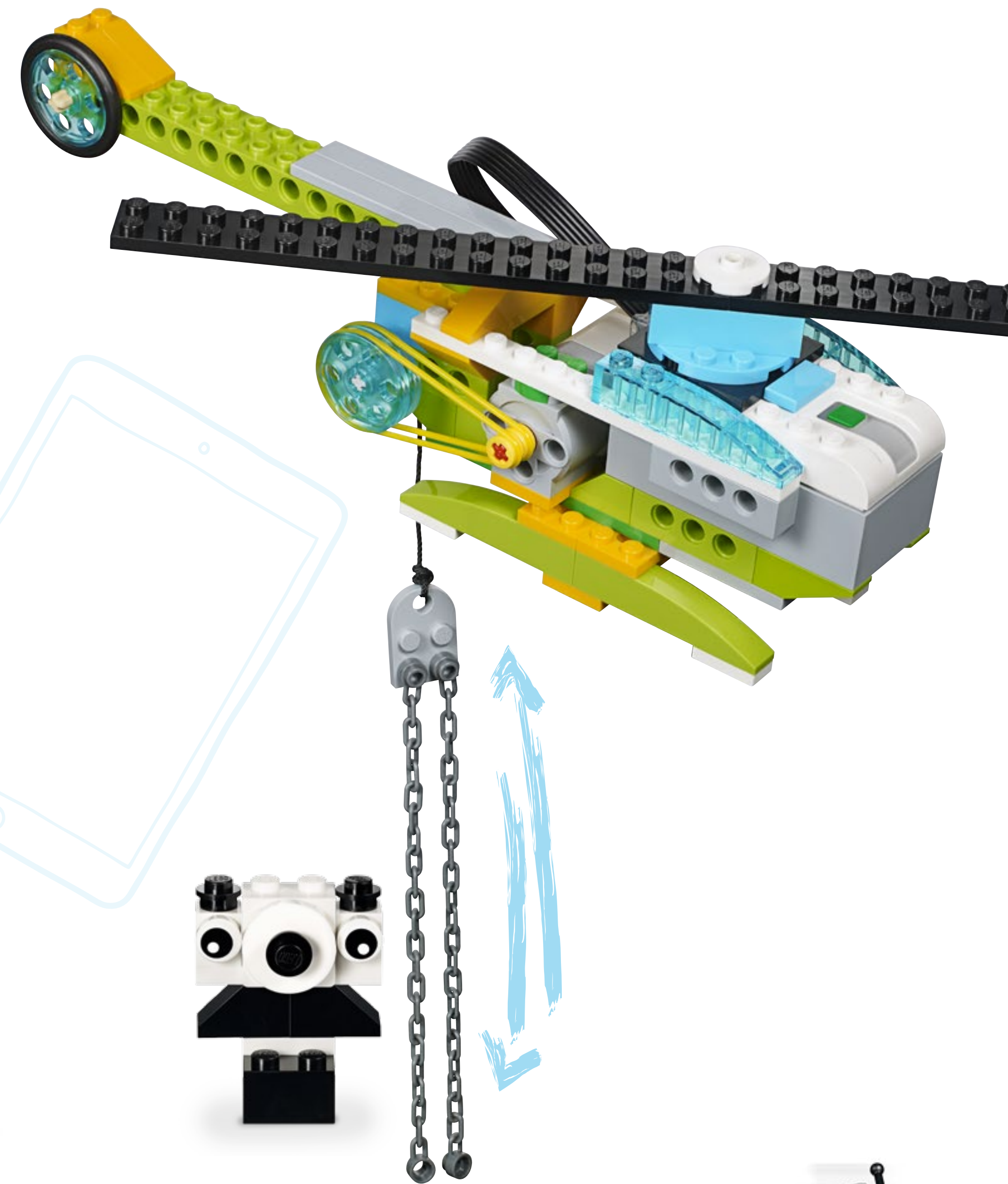

LEGOeducation.com

LEGO and the LEGO logo are trademarks of the/son des marques de commerce du/son marcas registradas de LEGO Group.
©2017 The LEGO Group. 2017.01.01. - VI.

